



KABA[®]

Narrow Style Series Mortice Lock Furniture

Designed for use with contemporary Australian narrow style mortice locks

Narrow Style Series Mortice Lock Furniture

The Kaba Narrow Style furniture series is designed for use with the Kaba SBM Narrow Style mortice latch & similar products. Available in square end N600 Series and round end N100 series to compliment the modern architectural design of lever handles in Kaba's range of door furniture.

Features

Constructed from forged brass handles and plates including an integrated precision ground bush providing superior handle support and combined with a

heavy duty compression spring eliminates lever handle sag.

Fixing

Plates are 12mm thick and are designed to fit back to back with 2 x M4 through fix screws. Concealed fixing to outside and Visible fixing to inside. Screws supplied with concealed plates only.

Handing

The levers are Non-Handed & easily converted on site by rotating lever 180°.

Door Thickness

Supplied with 2 x lengths of fixing screws (2 x 55mm & 2 x 68mm), the Kaba Narrow Style furniture series is supplied to suit door thickness 32mm to 50mm.

Thicker doors require extended spindles, turn bars & fixing screws.

Lever and Knob Design

Plates are only available in the 25 Lever handle design.



N100 Plate with lever - concealed



N600 Plate with cylinder hole - concealed



N600 Plate with turn and lever - concealed

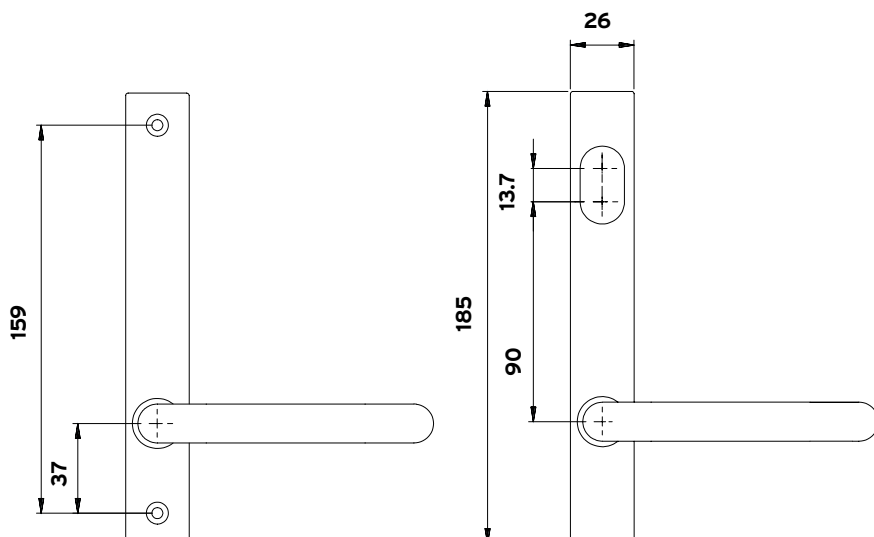

Standard Finishes

Satin Chrome Plate SCP

CODE



CYLINDER



TURN

Narrow Style Series Functions

N100 Series - Round End

Concealed

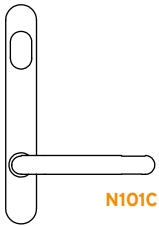

N101C

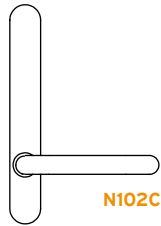

N102C

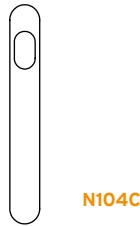

N104C

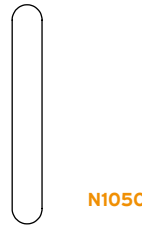

N105C

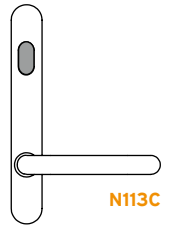

N113C

Visible

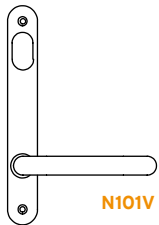

N101V

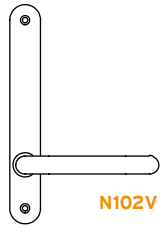

N102V

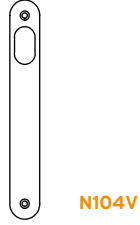

N104V

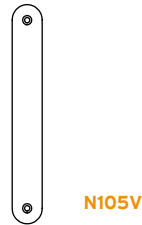

N105V

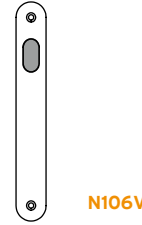

N106V

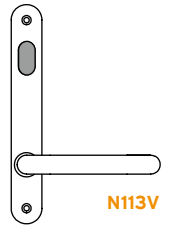

N113V

N101 Function
Plate with cylinder hole
and lever

N102 Function
Plate with lever

N104 Function
Plate with cylinder hole

N105 Function
Plain plate

N106 Function
Plate with turn

N113 Function
Plate with turn and
lever

N600 Series - Square End

Concealed

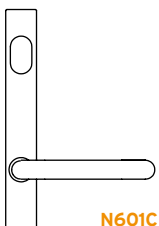

N601C

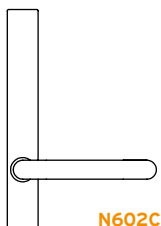

N602C

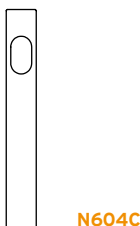

N604C

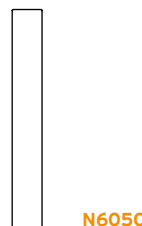

N605C

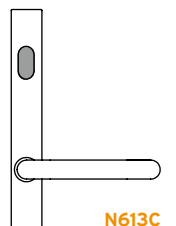

N613C

Visible

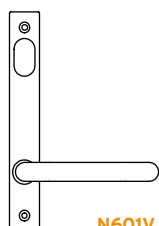

N601V

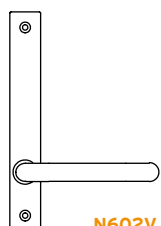

N602V

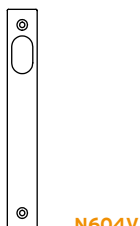

N604V

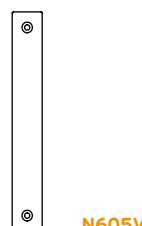

N605V

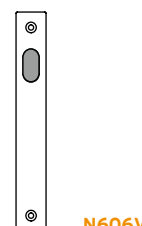

N606V

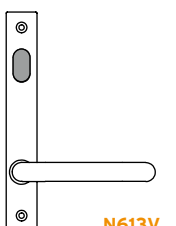

N613V

N601 Function
Plate with cylinder hole
and lever

N602 Function
Plate with lever

N604 Function
Plate with cylinder hole

N605 Function
Plain plate

N606 Function
Plate with turn

N613 Function
Plate with turn and
lever



Kaba Australia Pty Limited

HEAD OFFICE - NSW

Unit 4, 42-44 Redfern Street
Wetherill Park NSW 2164

QLD - 2/40 Proprietary Street
Tingalpa QLD 4173

SA - 55/55 Melbourne Street
North Adelaide SA 5006

WA - Unit 1, 10 Vulcan Road
Canning Vale WA 6155

Sales Tel: 1300 728 088
Sales Fax: 1300 728 708

www.kaba.com.au

NQLD - N.B. Agencies Pty Limited

56 Leigh Street, West End
Townsville QLD 4810

Tel: 07 4771 3400
Fax: 07 4771 4955

sales@nbagencies.com.au