

Power Size	Max. Door Width	Max. Door Weight	Max. Door Opening	Min. Closing Torque	Number Turns
EN1	750mm	20kg	175°	9Nm	0
EN2	850mm	40kg	175°	13Nm	3*
EN3	950mm	60kg	175°	18Nm	8
EN4	1100mm	80kg	175°	26Nm	13
EN5	1250mm	100kg	175°	37Nm	18

* - Factory default setting

2615 SERIES SIZE 1 - 5 CAM ACTION DOORCLOSER

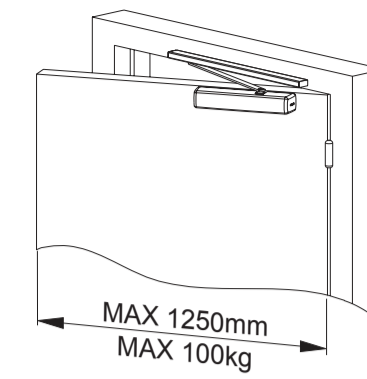

SLIDE ARM FIXING
(RIGHT HAND DOOR PULL SIDE)

485

102

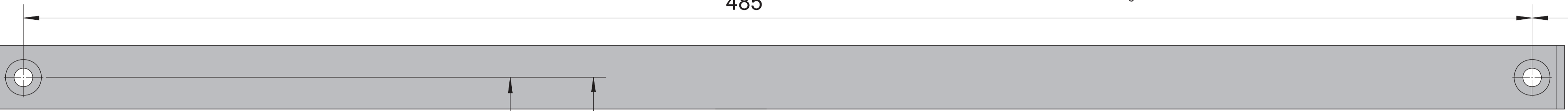

46

33

13

43

16

11

16

SLIDE ARM FIXING
RIGHT HAND PULL SIDE

100

213

160

142

MOUNTING POSITION FOR
2514-180SIL MOUNT BRACKET
IF REQUIRED.

DOOR FRAME

TOP OF DOOR

TURN UPSIDE DOWN FOR OVER DOOR MOUNTING

ARM HEIGHT ADJUSTMENT

0-14mm

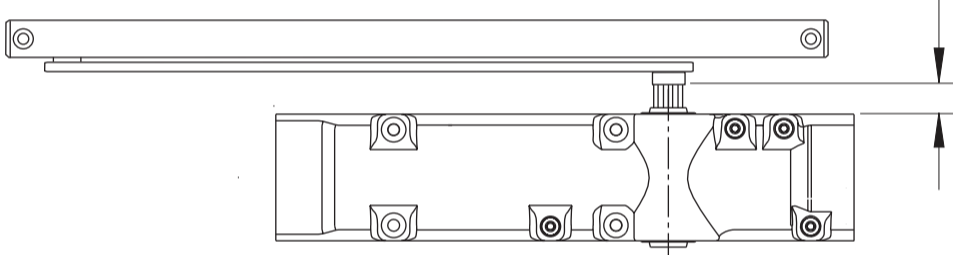

USE THIS TEMPLATE IN CONJUNCTION WITH THE 2615SSS/SIL MOUNTING INSTRUCTION (SUPPLIED)

Align template to door.
Mark & drill 4 body mounting holes and 2 slide rail holes.

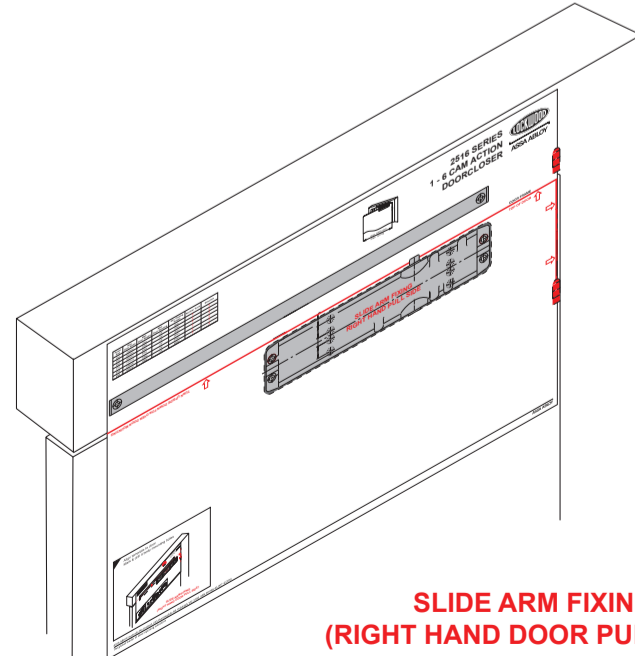

SLIDE ARM FIXING
(RIGHT HAND DOOR PULL SIDE)

PRE-LOADING OF THE ARM

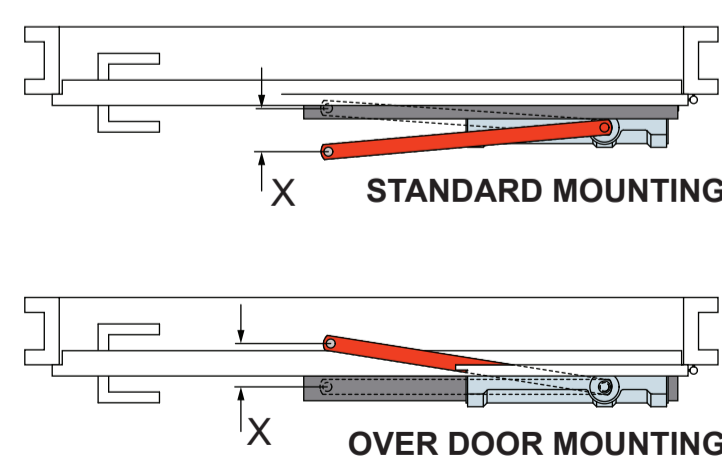

X=min 10mm...
max 70mm

Preload pinion as shown and assemble arm to pinion.

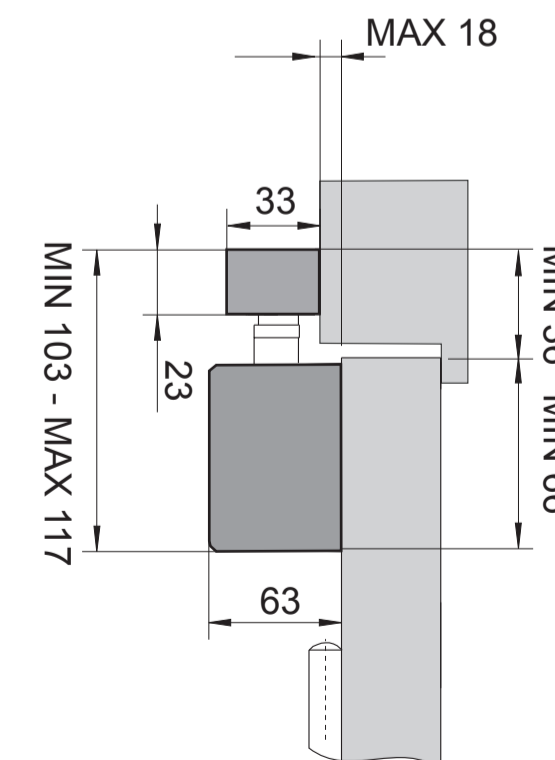

STANDARD MOUNTING

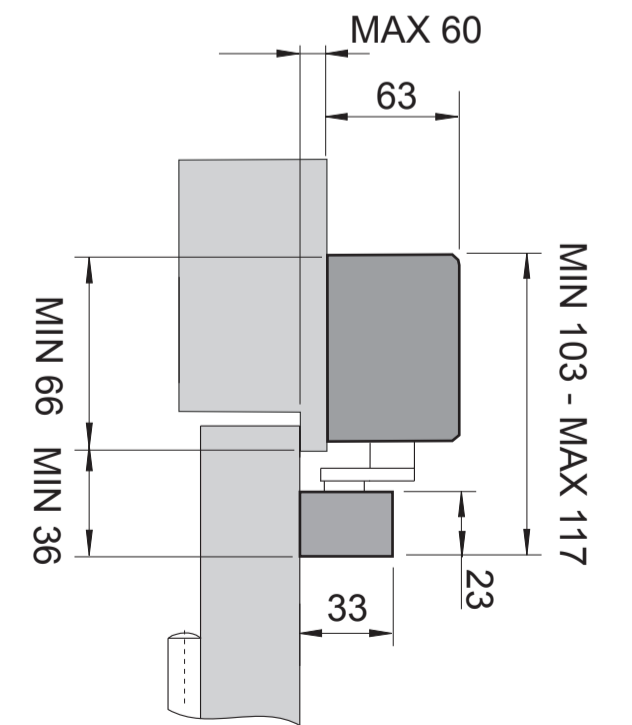

OVER DOOR MOUNTING

