



S-6000

DIGITAL TOUCHPAD
DOOR LOCK

USER MANUAL



ALLEGION™

Product **Features**



Three Way Access Solution

Three entry options: PIN code and smart card/fob. The unit also has a key override feature.



Random Security Code Function

You may press any numbers randomly without limitation, and then enter your PIN code as the final sequence. This feature allows access without revealing your PIN code to others.



Panic Release Handle Type

This feature facilitates quick exits, opening the door easily with a simple lever action.



Highly Reliable Lock Type

The S-6000 features a reliable mechanical mortice lock.



Auto lock/Auto re-lock function

When the door is closed, the lock engages automatically. If users do not open the door after unlocking it, the lock will re-engage automatically.



Privacy function

When privacy function is activated, the door cannot be opened from outside, even with the registered card/fob or entry code.



Excessive force alarm

If excessive force is used to try to bypass the lock, the lock function is suspended and an alarm will sound.



Preventing illegal entry and hacking

If an incorrect entry code is used 5 times, the door lock function is suspended and an alarm will sound.



Battery level indicator

Replace batteries when low battery indicator light shows and alarm sounds.

Safety Precautions



Do not disassemble or alter the lock. Disassembling the door lock may damage the product. Damage to the product caused by unauthorised persons may void the warranty.



Please keep the product away from water or any liquids. If the product is exposed to water or liquids, please wipe the moisture off with a soft cloth. If moisture or foreign materials penetrate the product, remove the batteries immediately.



Please check the batteries every 6 months for leaks/cleanliness. If leakage is discovered, please wipe out with a dry cloth and replace with new batteries. In case of exposure to leakage, wash affected skin area with soap and water immediately.



Do not clean the product with flammable materials such as alcohol, benzene or thinners. Such materials may damage the surface of the lock or cause a fire.



Batteries should not be exposed directly to heat sources or submerged in water, because they may leak or explode, resulting in severe damage. Do not use damaged batteries.



Do not allow the battery electrodes to make contact with metals such as keys, as the battery may overheat, causing an explosion or severe damage.



Please do not close the door with the deadbolt in the locked position. It may damage the product or cause a malfunction.



Do not mix old and new batteries, or use different types of batteries. Ensure the + and - ends of the batteries are positioned correctly. Incorrect positioning may cause leaks and/or an explosion.

User Manual **Index**

Introduction & Basic Functions

Product components	4
Front of lock	5
Back of lock	6
Checking battery status	7
Replacing batteries	7
Emergency power	8
Manual override	8
Random security coding	9
Auto/manual locking system	9
Opening door from outside	10
Locking door from outside	11
Opening/Locking Door From the Inside	12

Applications

Privacy function	13
Auto locking function	14
Auto-relocking function	14
Alarm & warning functions	15
System reset	16
Setting volume level	17

Registering entry PINs	18
Registering cards/fobs	19
Deleting entry PINs	19
Registering Remote Key	20

Product **Components**

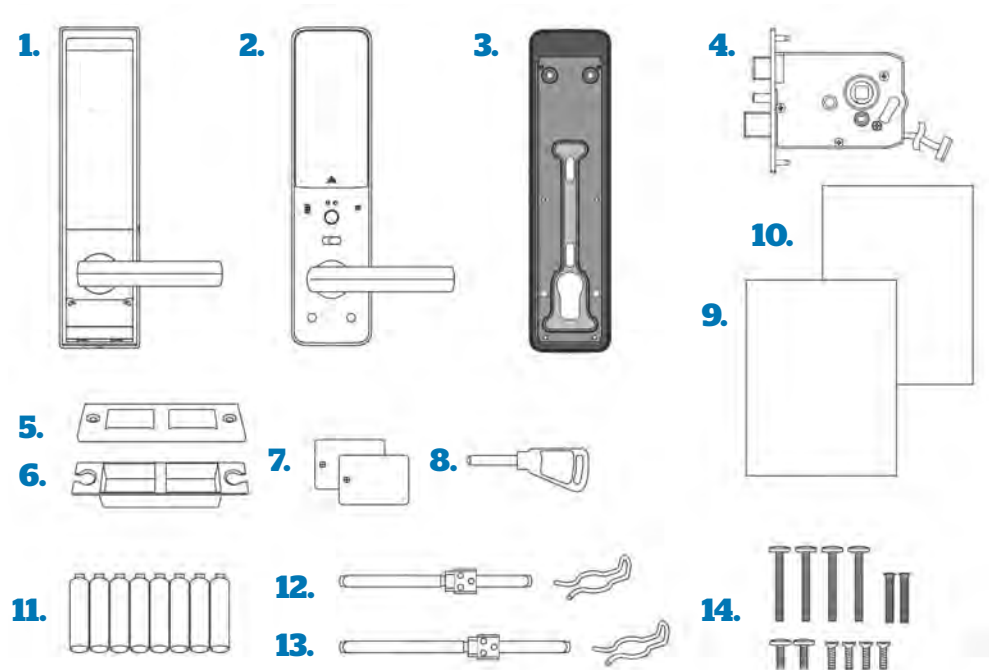

Name

1. Front assembly
2. Back assembly
3. Back cover
4. Mortice Lock
5. Strike plate
6. Strike housing
7. Card/fob
8. Key
9. User manual
10. Installation template
11. Batteries
12. Handle shaft (40-50mm thick door)
13. Handle shaft (50-90mm thick door)
14. Screws

Specification/Detail

- 76mm (W) x306mm (H) x28mm (D)
- 71mm (W) x298.6mm (H) x30.7mm (D)
- 76mm (W) x303.6mm (H) x7.9mm (D)
- 123mm (W) x 109.5mm (H) x 24.5mm (D)
- 36mm (W) x 106mm (H) x 1.5mm (D)
- 24mm (W) x 102mm (H) x 18mm (D)
- 2x card, 2x fob, 2x patch
- 3x
- Includes warranty form
- For door preparation
- 8 pieces (1.5v, AA, LR6 alkaline)
- 89(W) X 12(H) X 12(D)mm + stop-ring
- 126.9(W) X 12(H) X 12(D)mm + stop-ring
- 5 x 30mm - 4 of each for back cover
- 5 x 24mm - 2 of each for inner lower part
- 5 x 8mm - 2 of each for inner upper part
- 3/16" x 1/2" - 4ea. for mortice and strike
- 4 x 19mm - 4ea. for front/back plate

Front of Lock

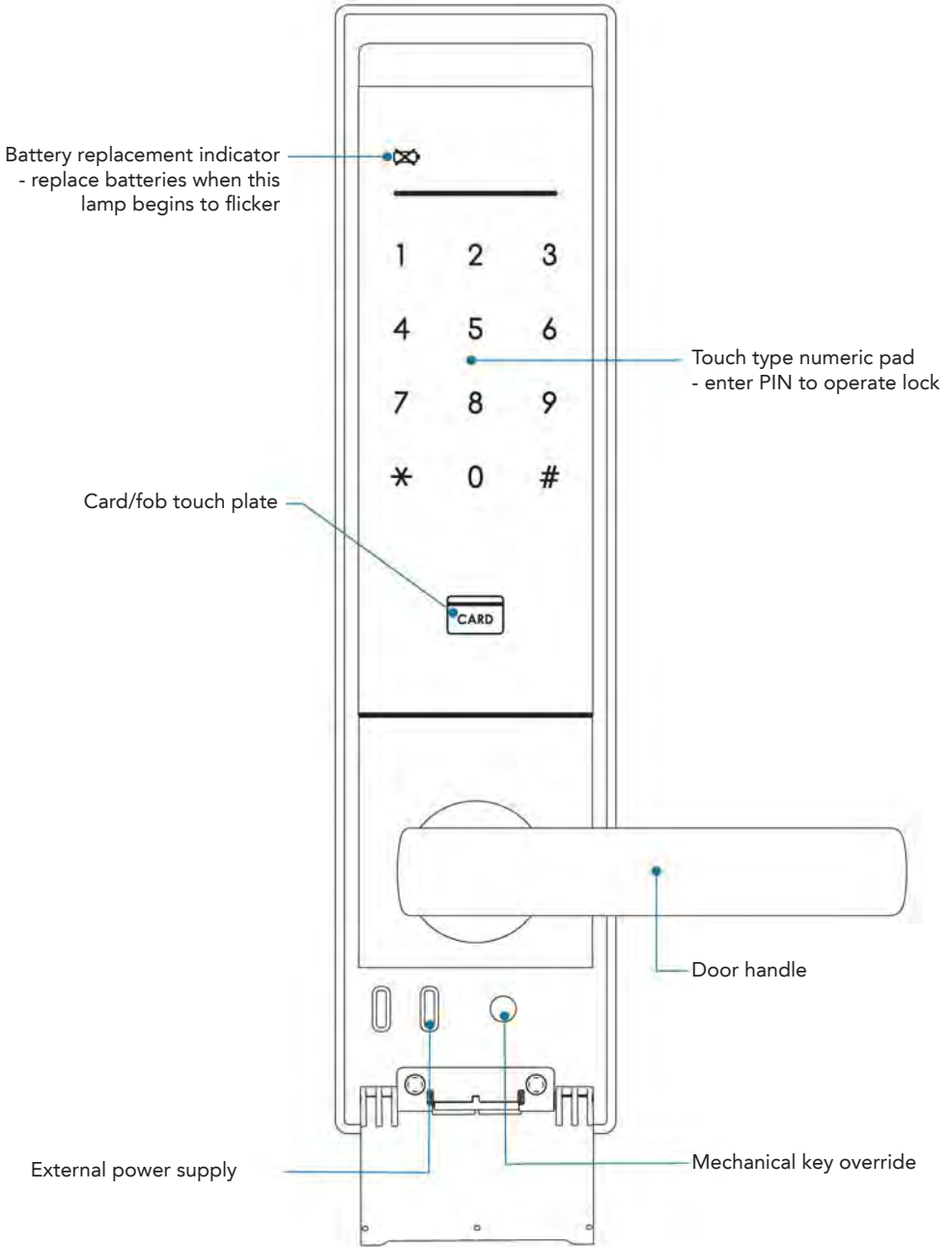

Back of Lock

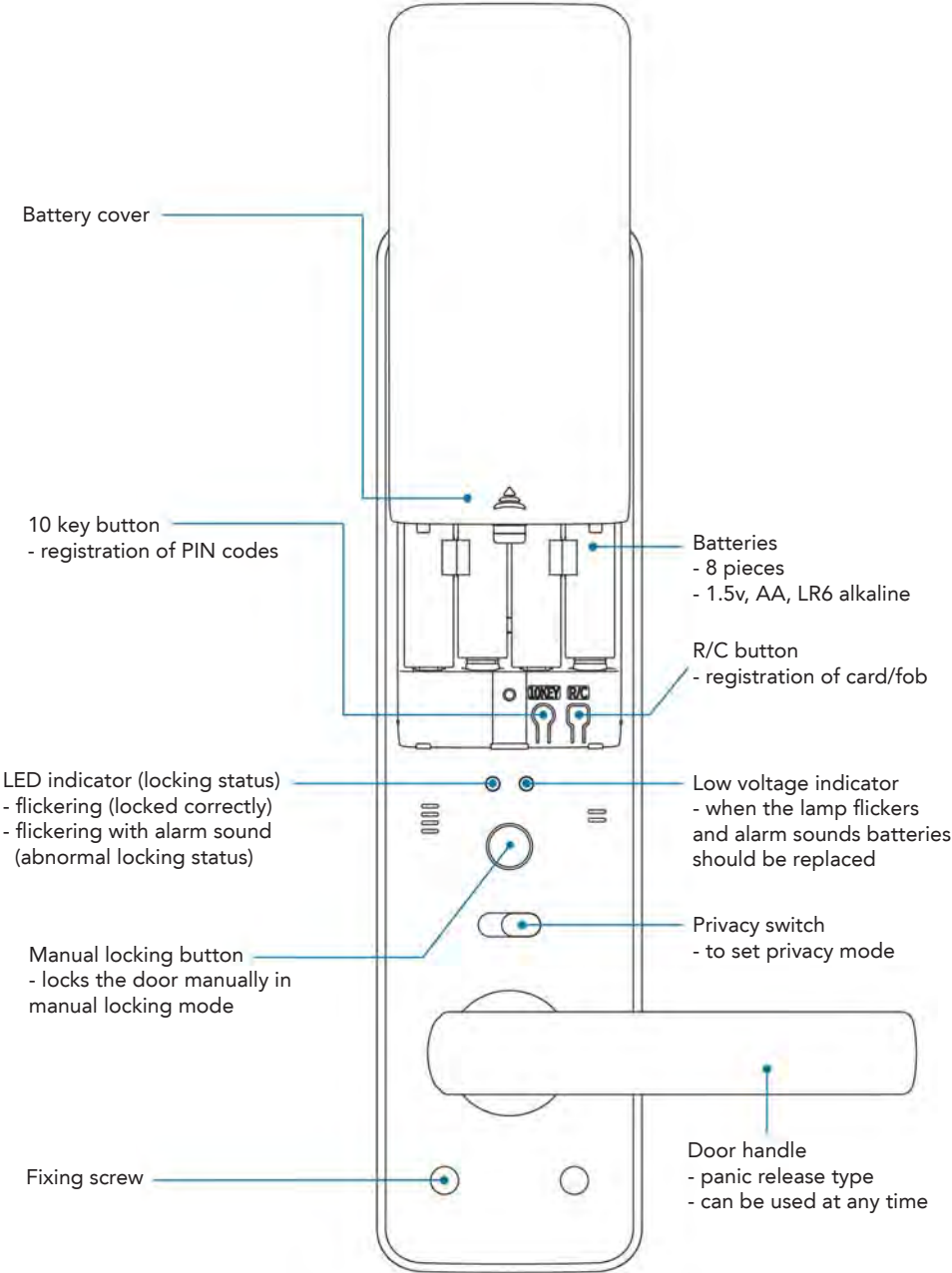

Battery Status & Replacement

Check battery status (door must be closed)

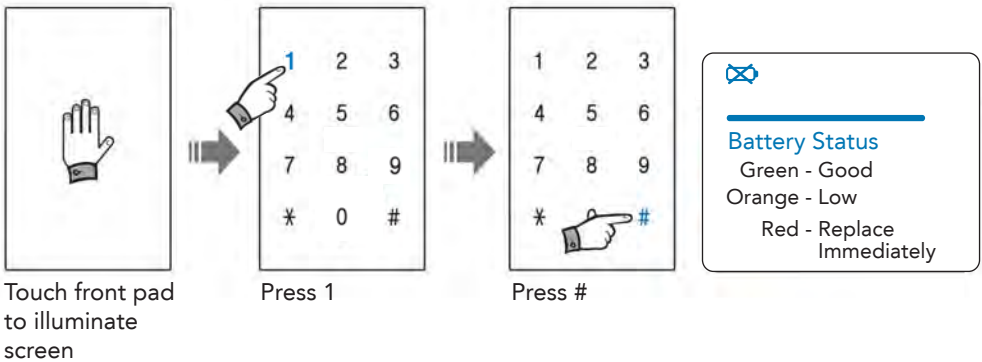

Battery replacement

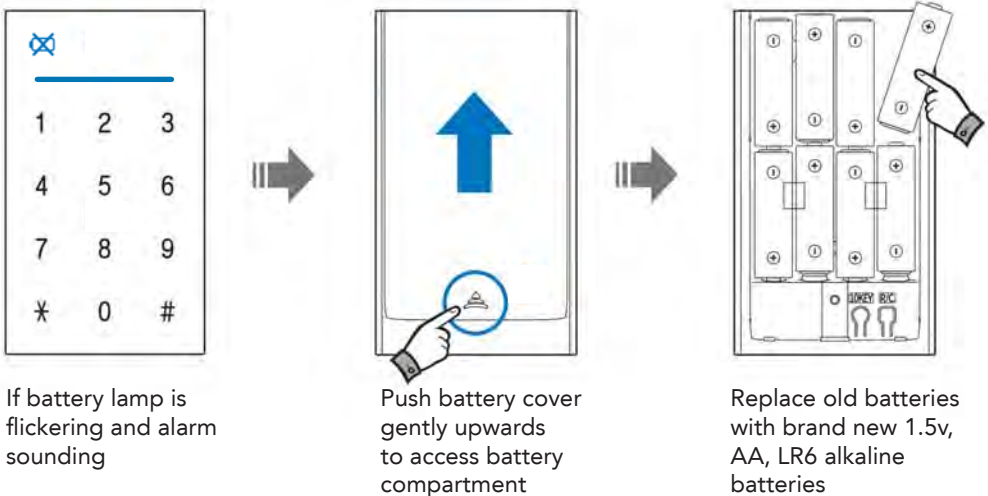

NOTE

- The life of batteries is around one year, based on ten entries/exits per day.
- Battery life can vary depending on battery's manufacturer, production date, installation environment and usage frequency.
- Second hand batteries and/or the use of batteries other than those specified is likely to cause a malfunction.
- Do not use rechargeable batteries as battery leakage may occur.
- Check batteries at least every 6 months and if there is any leakage, replace with new batteries.

Emergency Power & Manual Override

How to apply external power if batteries run out

When the batteries are entirely exhausted, a 9V battery can be used on the emergency power terminals to allow access. Once the door lock has been reactivated by the 9V battery, access can be gained via PIN, card/fob or fingerprint. The batteries in the back of the lock can then be replaced (see p.7).



Front pad will not illuminate when batteries are exhausted

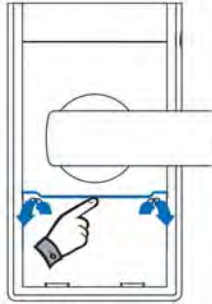

Open cover directly beneath front door handle

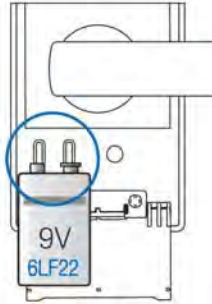

Touch terminals with 9V battery (place + and - on either terminal)

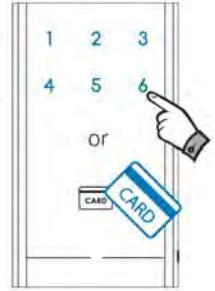

Access via PIN or card/fob

How to use mechanical override key

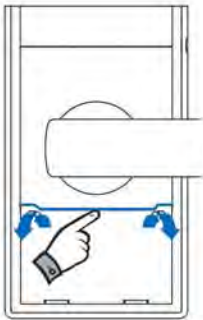

Open cover directly beneath front door handle

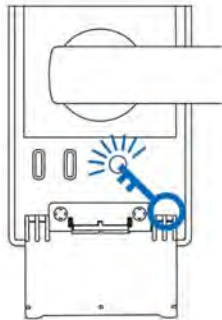

Insert manual override key and rotate

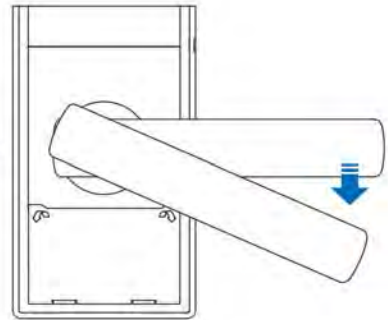

Door handle can now be rotated for access

NOTE

- Please keep manual override key in a safe, separate place for use in emergencies.

Random Security Coding

When you enter your home with other people present, you may not wish to show them your PIN code. If this is the case, you may press any numbers randomly without limitation, and then enter your PIN code as the final sequence. This will prevent others from seeing your PIN code.



Enter in any random sequence of numbers you desire e.g 1389

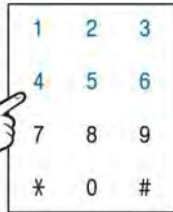

After the sequence of random numbers is entered, enter your PIN to access e.g 1234

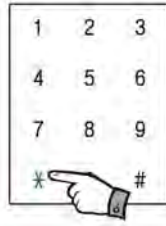

Press * to enter

Auto/Manual Locking

How to set auto/manual locking system

- In auto-locking mode, door will be locked automatically after it is closed.
- In manual locking mode, the door is locked by pressing the manual lock button after the door is closed.



Touch the front pad

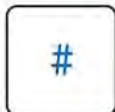

Press #



Input user PIN

or



Touch card/fob



Press #



Press 5 for auto-locking mode



Press 6 for manual locking mode

NOTE

- Once mode has been set, pull down handle and close door.
- In manual locking mode, door can be unlocked by PIN, card/fob or by using inside handle.

Opening the Door From the **Outside**

Opening the door using a PIN

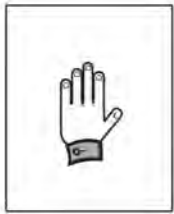

Touch the front pad

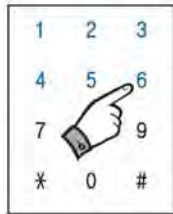

Enter PIN code e.g. 1234

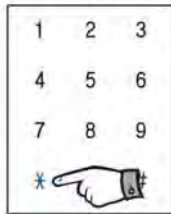

Press *



Pull down the handle and open

Opening the door using card/fob



1. Touch the registered card/fob to contact point in centre of keypad

2. Pull down the handle and open the door

Open the door with the sound muted

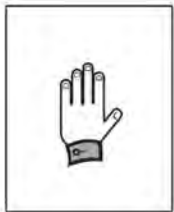

Press the front pad with finger tip for 3 seconds



Green LED will flash twice

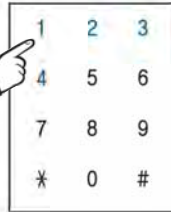

Enter PIN code e.g. 1234. Card/fob or fingerprint can also be used

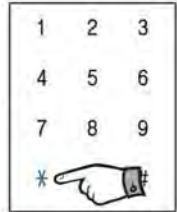

Press * and the door will unlock. Pull down the handle and open the door

NOTE

- Mute mode is sustained for 10 seconds.
- If the door handle is not used after applying one of the entry methods listed above, the unit will emit a sound and automatically re-lock after 7 seconds. This feature cannot be de-activated.

Locking the Door From the **Outside**

Locking the door in auto-locking mode

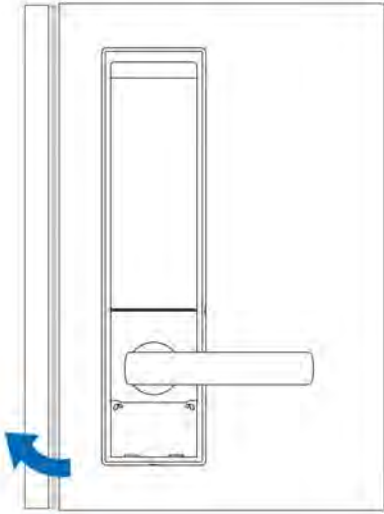

When the door is closed it is locked automatically and the unit will emit a sound to confirm the door has been locked.

If the door is not closed correctly, it will not be able to lock, and an alarm will sound. If the alarm sounds, please ensure that the door is closed correctly.

Locking the door in manual locking mode

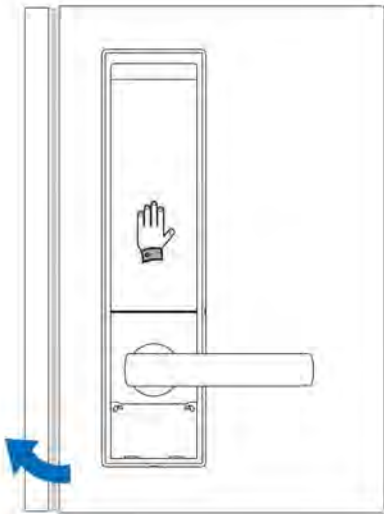

Close the door and touch the front pad

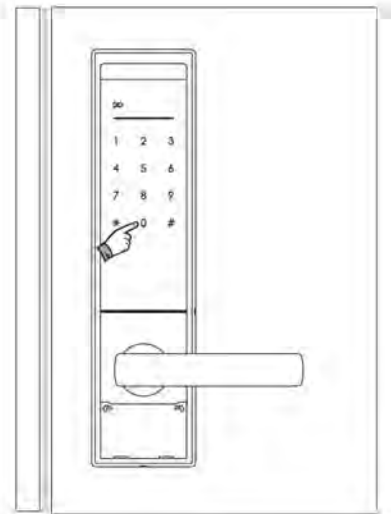

Press 0 and the door will lock

NOTE

- In manual locking mode, door will not lock automatically.
- Confirm the the door is closed/locked by pull down the handle.

Opening/Locking Door From the **Inside**

Opening the door from the inside

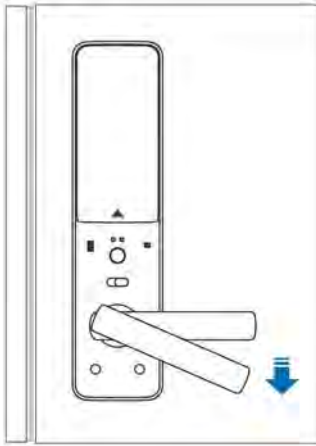

Panic Release Feature

The door can be opened from the inside at any time by simply pulling down the handle.

This feature allows easy escape in case of an emergency.

Locking the door from the inside

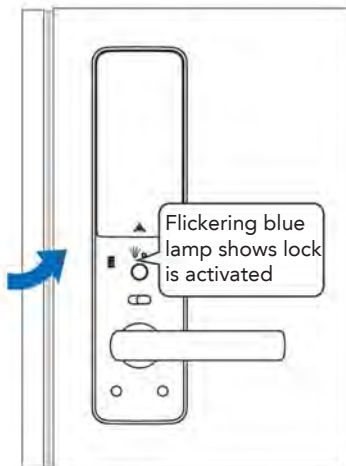

Auto-locking mode

When the door is closed, the door will lock and the unit will emit a sound

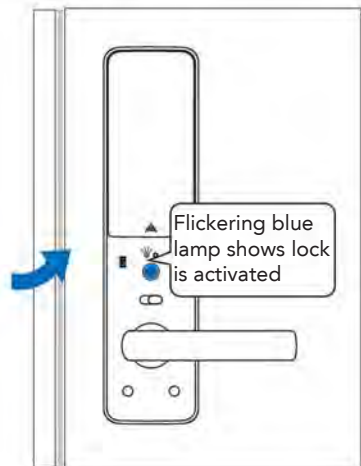

Manual locking mode

After closing the door, press manual lock button and the door will lock. The lock will emit a sound

NOTE

- Before closing the door, make sure that the deadbolt is not extended.
- If the door is not closed/locked correctly, a warning sound will be emitted.

Privacy Function

Activating privacy mode so lock cannot be unlocked from the outside

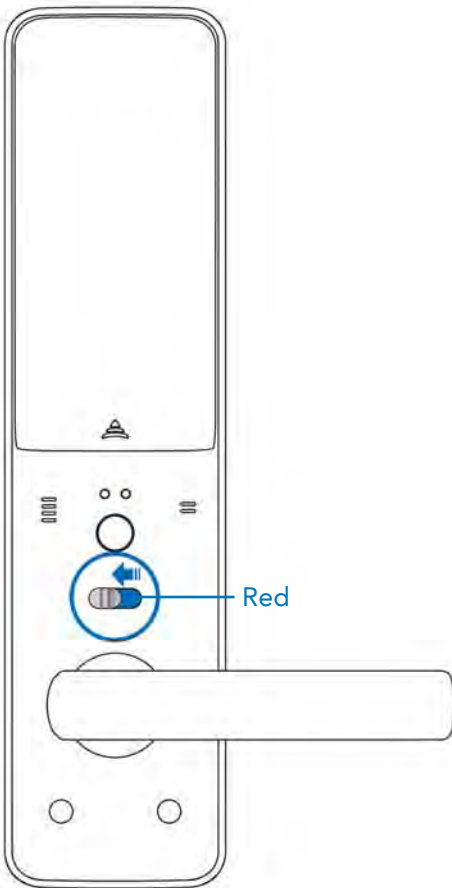

Privacy mode ON

Door cannot be unlocked from the outside

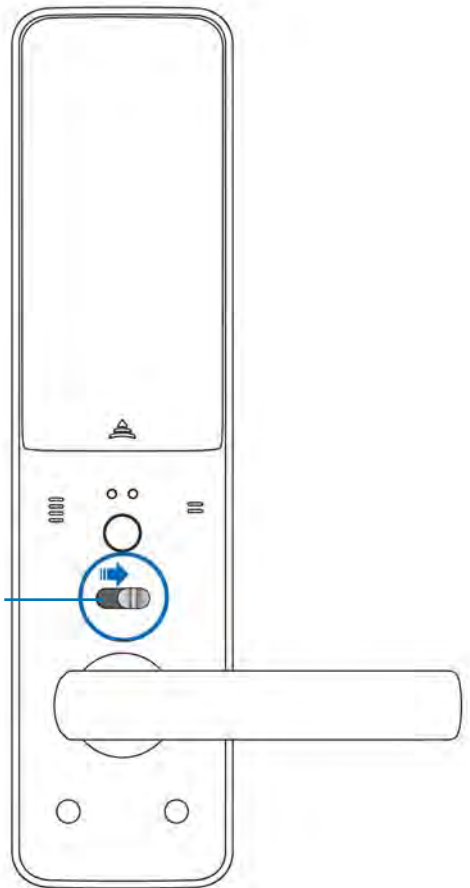

Privacy mode OFF

Normal operation. Door can be unlocked from the outside

NOTE

- Privacy mode can only be activated when the door is locked.
- Even in privacy mode the door handle is still able to be used from the inside. When the door handle is used from the inside, privacy mode is deactivated.
- The lock can be unlocked from the outside with the mechanical key, even when privacy mode is on.

Auto **Locking** Function

Auto locking system

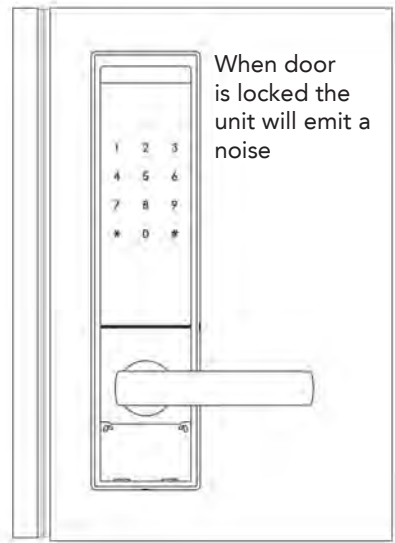
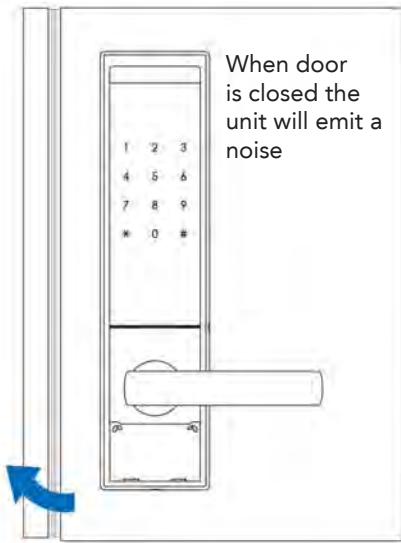

Auto re-locking system

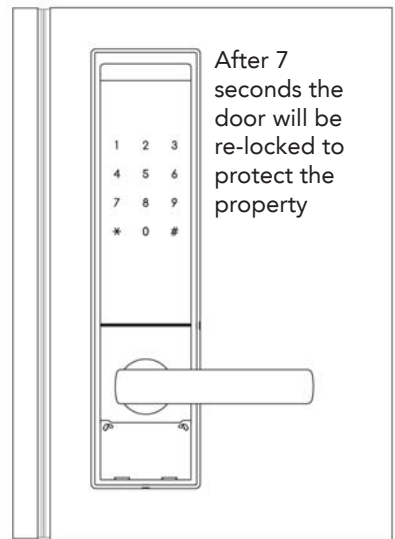
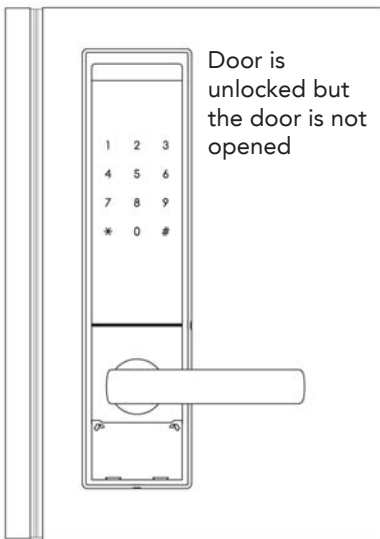

NOTE

- The auto-relocking system cannot be deactivated.

Alarm & Warning Functions

Preventing illegal entry and hacking

The unit will emit a strong alarm sound for one minute in the following situations:

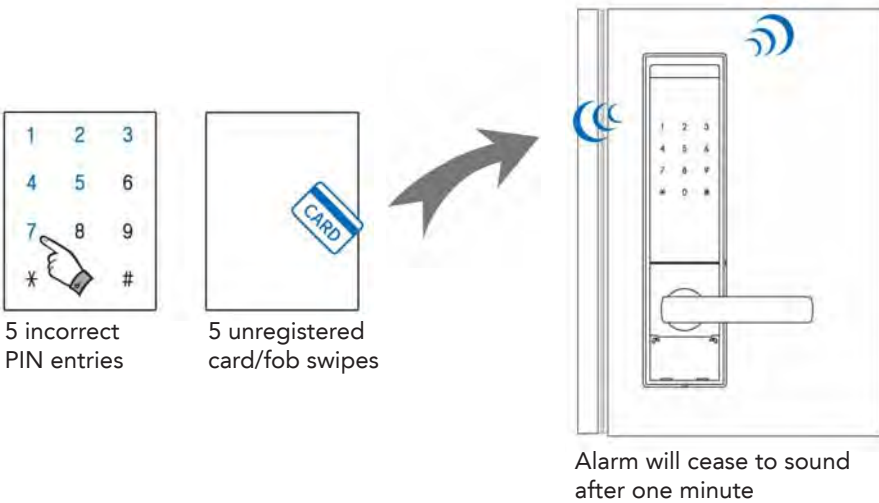

Preventing forced entry

If an attempt is made to force the door or lock open, the unit will emit a strong alarm sound for one minute. Follow the instructions below to stop the alarm sounding:

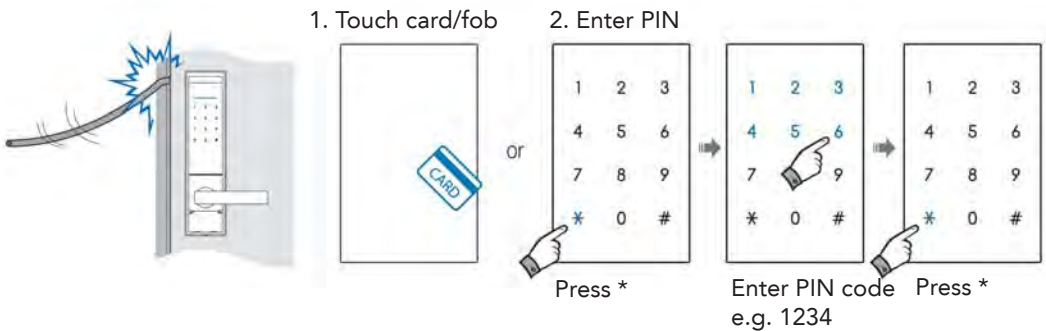

NOTE Manual lock button will stop the alarm sounding.

System **Reset**

The unit can be reset to its factory settings by following these steps



1. Open battery cover

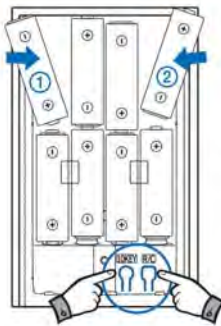

2. Hold down both the 10KEY and R/C buttons for 3 seconds



3. Press 0 + # keys, all data will be deleted

Setting **Volume**

How to control volume level

There are eight sound volume levels to choose from, ranging from mute to maximum

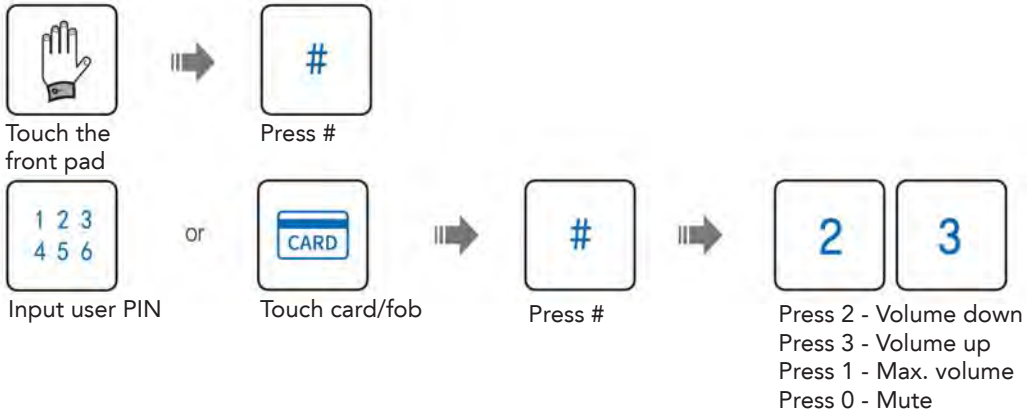

NOTE

- In mute status, keypad lamp will flicker when PIN is entered.
- Once volume has been set, pull down handle and close the door.

Registering **Entry PINs**

Registering entry PIN codes



Open battery cover and press 10KEY

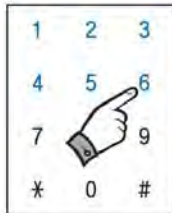

Enter new entry PIN e.g. 1234



Press * button
- Unit will emit sound to confirm PIN has been set

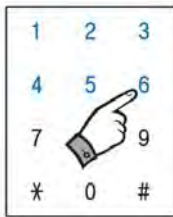

OPTIONAL
Add additional PIN codes if required (one at a time)

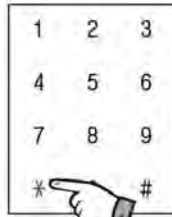

Press * to add another PIN, or press * twice to exit programming

NOTE

- Factory setting PIN code is 1234.
- A maximum of 8 PIN codes can be registered with 4 to 12 digits each.
- Previous PIN code(s) are deleted automatically with registration of new PIN code(s)
- Set-up or delete new PIN codes when the door is open to prevent unintentional locking.
- After changing a PIN code or entering a new PIN code, verify it by unlocking the door with the new PIN code.

Registering and Deleting **Cards & Fobs**

How to register cards and fobs

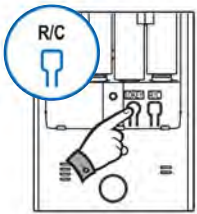

Open battery cover and press R/C



Touch the cards/fobs one by one. A maximum of 20 can be registered

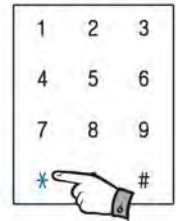

Press * button to complete registration

How to delete cards and fobs

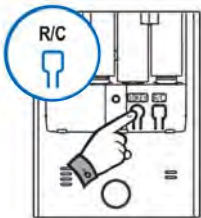

Open battery cover and press R/C

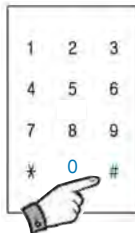

Press 0 + # keys, all data will be deleted

NOTE

- Previous card/fob memory is deleted automatically after registration of new card(s)/fobs(s).
- Max. 20 cards/fobs can be registered.
- For higher security, please use cards/fobs which are supplied by Schlage.

Registering Remote Key

How to register remote key

Max, 10EA of remote key can be registered

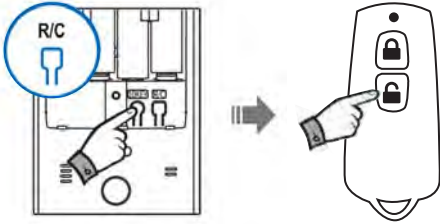

Open battery cover and press R/C

Press any button on remote key
* For registration of several remote keys, press button of each key one by one

How to delete remote key (Delete all)

Warning: card key and fob will be deleted too

Portable remote key

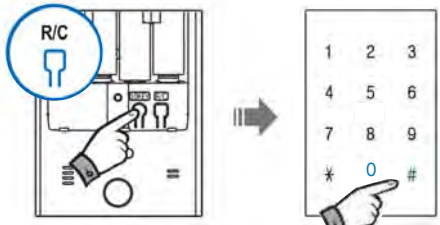

Open battery cover and press R/C

Press 0 + # keys, all data will be deleted

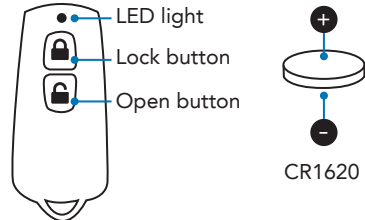

- Remote key is optional accessory. One round battery (CR1620) is equipped
- To replace battery, open the back cover by screw driver

NOTE

- Other radio devices can effect the operation of remote key.
- With registration of new remote key, previous remote keys and card keys will be deleted automatically.
- Once the remote key is operated for more than 1,000 times when out of range, remote key will no longer work.
- If the operating distance of remote key is shortened with dim light or not working entirely, please replace the battery (ensure correct position of +/-).

MEMO



Allegion (Australia) Pty Ltd
Phone 1800 098 094
www.allegion.com.au

Allegion South East Asia
Phone +65 6488 2562
www.allegion.com

Allegion (New Zealand) Limited
Phone 0800 477 869
www.allegion.co.nz