



Miles Nelson was established in 1928 to manufacture high quality hardware products from a central Auckland factory in Airedale Street. Now located on Auckland's North Shore, the company supplies a wide range of imported and locally manufactured hardware products, maintaining a reputation for high quality products and excellence in customer service. Miles Nelson is New Zealand owned and operated and takes pride in designing and supplying innovative hardware products for the building industry. If you require any further information about the products shown on the following pages, please contact us and we can arrange for one of our representatives to visit you.



PRODUCT CATALOGUE

BANNISTER BRACKETS
BATHROOM FITTINGS
CABIN HOOKS
CABINET HARDWARE & HANDLES
DOOR FITTINGS
DOOR HANDLES
DOOR STOPS
HINGES
HOOKS
KICK PLATES, PUSH PLATES & GRAB RAILS
LETTER BOX LETTERS & NUMBERS/LETTER PLATES
NECK BOLTS
SECURITY FITTINGS
SOCKET BOLTS
WINDOW FITTINGS

- It is a condition of the sale that the CONSUMERS GUARANTEES ACT will not apply to any goods acquired for business purposes.
- These products have NOT been designed specifically for marine environments and as such it is incumbent on the purchaser to ensure their suitability.
- Dimensions nominal.
- Product may vary from photo.
- Miles Nelson reserves the right to alter or delete product, finish or change specification without notice.

Common Finishes Glossary

- | | | |
|--------------------------------|-------------------------|-----------------------|
| •BN – Brushed Nickel | •BR – Brass Finish | •CP- Chrome Finish |
| •FB – Florentine Bronze Finish | •PW – Powder coat White | •RM – Raw Material |
| •SC – Satin Chrome | •SN – Satin Nickel | •SS – Stainless Steel |

Miles Nelson Manufacturing Ltd

PO Box 31-043, Milford, Auckland, New Zealand

Phone – (09) 489 7225 Toll free- 0800 663 576

Fax – (09) 489 5552

www.milesnelson.co.nz

BANNISTER BRACKETS

LUMOS ILLUMINATED BANNISTER BRACKET

Designed by Miles Nelson

LED handrail bracket with concealed fixings supplied
 Easy installation – instructions enclosed.
 Environmentally friendly with a very low power consumption.
 LED bulb life approx 12 years under continuous use.
 Adapter for flat profile mouldings included.
 Complies with BIA acceptable solution D1/AS1.

Use only a Miles Nelson regulated power transformer to power Lumos. Failure to do so will void warranty.
 Patent Pending – Patent 542117, Design Application 406 530.

PRODUCT CODE	DESCRIPTION	QTY	PER	PCK
610SCBP (INTERIOR)	BRACKET W/LIGHT S/CHROME	1	EA	4
610CP (INTERIOR)	BRACKET W/LIGHT CHROME	1	EA	4
611SCBP (INTERIOR)	BRACKET W/O LIGHT S/CHROME	1	EA	4
611CP (INTERIOR)	CHROME BRACKET W/O LIGHT	1	EA	4
610SCEBP (EXTERIOR)	SATIN BRACKET W/LIGHT P/COAT	1	EA	4
611SCEBP (EXTERIOR)	BRACKET W/O LIGHT P/COAT SATIN	1	EA	4

LUMOS TRANSFORMER

12 volt DC transformer.
 Each transformer can power 16 lights.

Tested to AS/NZS3108 at 25°C.

PRODUCT CODE	DESCRIPTION	QTY	PER	PCK
612PA	LUMOS POWER TRANSFORMER	1	EA	6

BANNISTER BRACKET - SQUARE COVER

Designed by Miles Nelson

Concealed fixing. Fixings and flat profile adaptor supplied.
 Complies with BIA acceptable solution D1/AS1.

PRODUCT CODE	DESCRIPTION	QTY	PER	PCK
312BR	BANNISTER BRCKT BRASS PLATED	1	EA	10
312SC	BANNISTER BRACKET S/CHROME	1	EA	10
312FB	BANNISTER BRACKET BRONZE	1	EA	10

BANNISTER SUPPORT BRACKET

Designed by Miles Nelson

Concealed fixing. Fixings supplied.

PRODUCT CODE	DESCRIPTION	QTY	PER	PCK
313SC	BANNISTER BRACKET S/CHROME	1	EA	10



BANNISTER BRACKETS

BANNISTER BRACKET - ROUND COVER

Designed by Miles Nelson

Concealed fixing. Fixings and flat profile adaptor supplied.
Complies with BIA acceptable solution D1/AS1.
Tested to exceed 300kg static load test.

PRODUCT CODE	DESCRIPTION	QTY	PER	PCK
310BR	BANNISTER BRCKT BRASS PLATED	1	EA	10
310CP	BANNISTER BRACKET CHROME	1	EA	10
310PW	BANNISTER BRACKET WHITE	1	EA	10
310SC	BANNISTER BRACKET S/CHROME	1	EA	10
310FB	BANNISTER BRACKET BRONZE	1	EA	10
310RM	BANNISTER BRACKET RAW FINISH	1	EA	10



HANDRAIL SUPPORT - ROUND COVER

Designed by Miles Nelson

Concealed fixing. Fixings and flat profile adaptor supplied.
Supplied with two hardened 8g surefast screws for base fixing.

PRODUCT CODE	DESCRIPTION	QTY	PER	PCK
311BR	BANNISTER BRCKT BRASS PLATED	1	EA	10
311CP	BANNISTER BRACKET CHROME	1	EA	10
311SC	BANNISTER BRACKET S/CHROME	1	EA	10
311FB	BANNISTER BRACKET BRONZE	1	EA	10



BANNISTER BRACKET

Fixings supplied.

PRODUCT CODE	DESCRIPTION	QTY	PER	PCK
110BR	BANNISTER BRCKT BRASS PLATED	1	EA	10
110CP	BANNISTER BRACKET CHROME	1	EA	10
110SC	BANNISTER BRACKET S/CHROME	1	EA	10



BANNISTER BRACKET

Made from Cast Aluminium.
Fixings supplied.
Powder coat finish suitable for exterior use.

PRODUCT CODE	DESCRIPTION	QTY	PER	PCK
210SC	BANNISTER BRCKT SATIN P/COAT	1	EA	10



BANNISTER BRACKETS

BANNISTER BRACKET - SQUARE

Designed by Miles Nelson.

Complies with BIA acceptable solution D1/AS1.
 Concealed fixing. Fixings supplied.
 Suitable for 45-55mm (1 3/4 - 2") diameter handrail
 Adaptor supplied for flat handrail profile

PRODUCT CODE	DESCRIPTION	QTY	PER	PCK
410SC	BANNISTER BRACKET S/CHROME	1	EA	8



BANNISTER BRACKET - STAINLESS STEEL 304

Manufactured from 304 Stainless Steel.
 Suitable for exterior use.
 Fixings supplied.

PRODUCT CODE	DESCRIPTION	QTY	PER	PCK
309SS	BANNISTER BRACKET S/STEEL	1	EA	2



BANNISTER BRACKET - STAINLESS STEEL 304

Manufactured from 304 Stainless Steel.
 Suitable for exterior use.
 Fixings supplied.

PRODUCT CODE	DESCRIPTION	QTY	PER	PCK
405SS	BANNISTER BRACKET S/STEEL	1	EA	2



BATHROOM FITTINGS

RINNOVA TOILET ROLL HOLDER

Polished chrome on solid brass.
European inspired design.
Concealed fixing.
DIY friendly installation.
5 year warranty.

PRODUCT CODE	DESCRIPTION	QTY	PER	PCK
796CP	TOILET ROLL HOLDER CHROME	1	EA	10

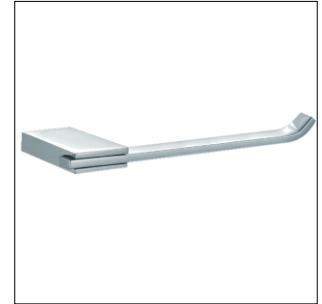

RINNOVA TOWEL RAIL

Polished chrome on solid brass.
European inspired design.
600MM overall length.
Concealed fixing.
DIY friendly installation.
5 year warranty.

PRODUCT CODE	DESCRIPTION	QTY	PER	PCK
795CP600	TOWEL RAIL CHROME	1	EA	10



RINNOVA TOWEL RING

Polished chrome on solid brass
European inspired design
Concealed fixing.
DIY friendly installation.
5 year warranty.

PRODUCT CODE	DESCRIPTION	QTY	PER	PCK
793CP	TOWEL RING CHROME	1	EA	10



RINNOVA ROBE HOOK

Polished chrome on solid brass.
European inspired design.
Concealed fixing.
DIY friendly installation.
5 year warranty.

PRODUCT CODE	DESCRIPTION	QTY	PER	PCK
794CP	ROBE HOOK CHROME	1	EA	10



RINNOVA SOAP DISH

Polished chrome on solid brass with glass soap holder.
European inspired design.
Concealed fixing.
DIY friendly installation.
5 year warranty.

PRODUCT CODE	DESCRIPTION	QTY	PER	PCK
791CP	SOAP DISH CHROME	1	EA	10



BATHROOM FITTINGS

RINNOVA SOAP DISPENSER

Polished chrome on solid brass with glass soap dispenser.
 European inspired design.
 Concealed fixing.
 DIY friendly installation.
 5 year warranty.

PRODUCT CODE	DESCRIPTION	QTY	PER	PCK
792CP	SOAP DISPENSER CHROME	1	EA	10



RINNOVA GLASS HOLDER

Polished chrome on solid brass with glass brush holder.
 European inspired design.
 DIY friendly installation.
 5 year warranty.

PRODUCT CODE	DESCRIPTION	QTY	PER	PCK
790CP	GLASS HOLDER CHROME	1	EA	10



RINNOVA TOILET BRUSH HOLDER

Polished chrome on solid brass with glass brush holder.
 European inspired design.
 Wall mounted.
 DIY friendly installation.
 5 year warranty.

PRODUCT CODE	DESCRIPTION	QTY	PER	PCK
797CP	TOILET BRUSH HOLDER CHROME	1	EA	10



BATHROOM FITTINGS

CASA CLASSICA GLASS HOLDER

Chrome on Brass with glass cup.
Modern design.
DIY friendly installation.
5 year warranty.
Concealed fixings.

PRODUCT CODE	DESCRIPTION	QTY	PER	PCK
590CP	GLASS HOLDER CHROME	1	EA	10



CASA CLASSICA SOAP HOLDER

Chrome on Brass with glass soap dish.
Modern design.
DIY friendly installation.
5 year warranty.
Concealed fixings.

PRODUCT CODE	DESCRIPTION	QTY	PER	PCK
591CP	SOAP HOLDER CHROME	1	EA	10



CASA CLASSICA SOAP DISPENSER

Chrome on Brass.
Modern design.
DIY friendly installation.
5 year warranty.
Concealed fixings.

PRODUCT CODE	DESCRIPTION	QTY	PER	PCK
592CP	SOAP DISPENSER CHROME	1	EA	10



CASA CLASSICA TOWEL RING

Chrome on Brass.
Modern design.
DIY friendly installation.
5 year warranty.
Concealed fixings.

PRODUCT CODE	DESCRIPTION	QTY	PER	PCK
593CP	TOWEL RING CHROME	1	EA	10



CASA CLASSICA ROBE HOOK

Chrome on Brass.
Modern design.
DIY friendly installation.
5 year warranty.
Concealed fixings.

PRODUCT CODE	DESCRIPTION	QTY	PER	PCK
594CP	ROBE HOOK CHROME	1	EA	10



BATHROOM FITTINGS

CASA CLASSICA TOWEL RAIL

Chrome on Brass.
 Modern design.
 DIY friendly installation.
 5 year warranty.
 Concealed fixings.

PRODUCT CODE	DESCRIPTION	QTY	PER	PCK
595CP600	TOWEL RAIL 600MM CHROME	1	EA	10



CASA CLASSICA TOILET ROLL HOLDER

Chrome on Brass.
 Modern design.
 DIY friendly installation.
 5 year warranty.
 Concealed fixings.

PRODUCT CODE	DESCRIPTION	QTY	PER	PCK
596CP	TOILET ROLL HOLDER CHROME	1	EA	10



CASA CLASSICA TOILET BRUSH HOLDER

Chrome on Brass with glass brush holder.
 Modern design.
 Wall mounted.
 DIY friendly installation.
 5 year warranty.
 Concealed fixings.

PRODUCT CODE	DESCRIPTION	QTY	PER	PCK
597CP	TOILET BRUSH HOLDER CHROME	1	EA	10



BATHROOM FITTINGS

TOWEL RAIL BRACKET (PAIR)

Packed in pairs, fixings supplied.
Suits 19mm tube.

PRODUCT CODE	DESCRIPTION	QTY	PER	PCK
024CP19TBP	END BRACKET CHROME	1	EA	10
024SC19TBP	END BRACKET S/CHROME	1	EA	10
024PW19TBP	END BRACKET WHITE	1	EA	10



CENTRE BRACKET (SINGLE UNIT)

1 bracket per pack, fixings supplied.
Suits 19mm tube.

PRODUCT CODE	DESCRIPTION	QTY	PER	PCK
024CP19CBP	CENTRE BRACKET CHROME	1	EA	10
024SC19CBP	CENTRE BRACKET S/CHROME	1	EA	10
024PW19CBP	CENTRE BRACKET WHITE	1	EA	10



END FLANGES (PAIR)

Packed in pairs, fixings supplied.
Suits 19mm tube. 25mm available in Chrome only.

PRODUCT CODE	DESCRIPTION	QTY	PER	PCK
107CP19BP	END FLANGES (19MM) CHROME	1	EA	10
107SC19BP	END FLANGES (19MM) S/CHROME	1	EA	10
107PW19BP	END FLANGES (19MM) WHITE	1	EA	10
107CP25	END FLANGES (25MM) CHROME	1	EA	10



TOWEL RAIL

Fixings supplied.
Rose diameter 68mm.
Rail thickness 10mm.

PRODUCT CODE	DESCRIPTION	QTY	PER	PCK
116CP250	TOWEL RAIL (250MM) CHROME	1	EA	10
116CP400	TOWEL RAIL (400MM) CHROME	1	EA	10
116CP600	TOWEL RAIL (600MM) CHROME	1	EA	10



TOWEL RAIL

Fixings supplied. 10mm diameter rail.

PRODUCT CODE	DESCRIPTION	QTY	PER	PCK
921CP300	TOWEL RAIL300MM CHROME	1	EA	1
921CP457	TOWEL RAIL457MM CHROME	1	EA	1
921CP600	TOWEL RAIL600MM CHROME	1	EA	1
921CP760	TOWEL RAIL760MM CHROME	1	EA	1



BATHROOM FITTINGS

TOWEL RAIL TUBING - ALUMINIUM - BRIGHT ANODISED

Fixings supplied.
19mm tube, bright anodised.

PRODUCT CODE	DESCRIPTION	QTY	PER	PCK
025CP19600	TUBE (600MM) BRIGHT ANODISED	1	EA	1
025CP19900	TUBE (900MM) BRIGHT ANODISED	1	EA	1
025CP191200	TUBE (1200MM) BRIGHT ANODISED	1	EA	1
025CP191800	TUBE (1800MM) BRIGHT ANODISED	1	EA	1
025CP192400	TUBE (2400MM) BRIGHT ANODISED	1	EA	1



TOWEL RAIL TUBING - ALUMINIUM - SATIN ANODISED

Fixings supplied.
19mm tube, satin anodised.

PRODUCT CODE	DESCRIPTION	QTY	PER	PCK
025SC19600	TUBE (600MM) SATIN ANODISED	1	EA	1
025SC19900	TUBE (900MM) SATIN ANODISED	1	EA	1
025SC191200	TUBE (1200MM) SATIN ANODISED	1	EA	1
025SC191800	TUBE (1800MM) SATIN ANODISED	1	EA	1
025SC192400	TUBE (2400MM) SATIN ANODISED	1	EA	1



TOWEL RAIL TUBING - ALUMINIUM - WHITE

Fixings supplied.
19mm tube, powdercoat white.

PRODUCT CODE	DESCRIPTION	QTY	PER	PCK
025PW19600	TOWEL TUBE (600MM) WHITE	1	EA	1
025PW19900	TUBE (900MM) WHITE TOWEL	1	EA	1
025PW191200	TUBE (1200MM) WHITE TOWEL	1	EA	1
025PW191800	TUBE (1800MM) WHITE TOWEL	1	EA	1
025PW192400	TUBE (2400MM) WHITE TOWEL	1	EA	1



TOILET ROLL HOLDER

Fixings supplied.
Economy range of toilet roll holders.
919 made from steel with 6mm diameter rod.
923 made from steel with 10mm diameter rod.

PRODUCT CODE	DESCRIPTION	QTY	PER	PCK
919CP	TOILET ROLL HOLDER CHROME	1	EA	10
923CP	TOILET ROLL HOLDER CHROME	1	EA	10
923SC	TOILER ROLL HOLDER S/CHROME	1	EA	10



BATHROOM FITTINGS

TOILET ROLL HOLDER

Fixings supplied.
Can be fixed left or right handed.

PRODUCT CODE	DESCRIPTION	QTY	PER	PCK
112CP	TOILET ROLL HOLDER CHROME	1	EA	10
112SC	TOILET ROLL HOLDER S/CHROME	1	EA	10
112PW	TOILET ROLL HOLDER WHITE	1	EA	10



TOWEL RING

Fixings supplied.

PRODUCT CODE	DESCRIPTION	QTY	PER	PCK
114CP	TOWEL RING CHROME	1	EA	10
114SC	TOWEL RING S/CHROME	1	EA	10
114PW	TOWEL RING WHITE	1	EA	10



TOILET ROLL HOLDER

Concealed fixing.
Fixings supplied.
Can be fixed left or right handed.
Made from aluminium with 10mm diameter rod.

PRODUCT CODE	DESCRIPTION	QTY	PER	PCK
115SC	ROLL HOLDER BRUSHED ALUM.	1	EA	10



TOILET ROLL HOLDER - STAINLESS STEEL

Fixings supplied.
Brushed Stainless Steel finish.
Suitable for commercial applications.

PRODUCT CODE	DESCRIPTION	QTY	PER	PCK
98120SS	TOILET ROLL HOLDER S/STEEL	1	EA	1



TOILET ROLL HOLDER – ADHESIVE BACKED

Adhesive backed mount.
Chrome on steel.

PRODUCT CODE	DESCRIPTION	QTY	PER	PCK
922CP	TOILET ROLL HOLDER CHROME	1	EA	10

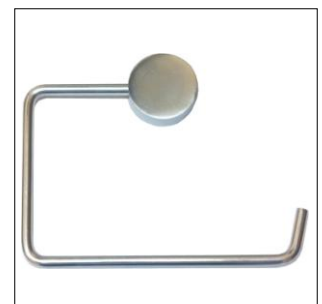

CABIN HOOKS

CABIN HOOK - FORGED SOLID BRASS

Stainless Steel fixings supplied. 50mm length, 8mm rod.

For hook eye use code 276**E where ** indicates finish code. I.e. 276BRE

PRODUCT CODE	DESCRIPTION	QTY	PER	PCK
276FB0850BP	CABIN HOOK (50MM) BRONZE	1	EA	10
276CP0850BP	CABIN HOOK (50MM) CHROME	1	EA	10
276BR0850BP	CABIN HOOK (50MM) BRASS	1	EA	10
276SC0850BP	CABIN HOOK (50MM) S/CHROME	1	EA	10



CABIN HOOK - FORGED SOLID BRASS

Stainless Steel fixings supplied. 75mm length, 8mm rod.

For hook eye use code 276**E where ** indicates finish code. I.e. 276BRE

PRODUCT CODE	DESCRIPTION	QTY	PER	PCK
276FB0875BP	CABIN HOOK (75MM) BRONZE	1	EA	10
276CP0875BP	CABIN HOOK (75MM) CHROME	1	EA	10
276BR0875BP	CABIN HOOK (75MM) BRASS	1	EA	10
276SC0875BP	CABIN HOOK (75MM) S/CHROME	1	EA	10



CABIN HOOK - FORGED SOLID BRASS

Stainless Steel fixings supplied. 100mm length, 8mm rod.

For hook eye use code 276**E where ** indicates finish code. I.e. 276BRE

PRODUCT CODE	DESCRIPTION	QTY	PER	PCK
276FB08100BP	CABIN HOOK (100MM) BRONZE	1	EA	10
276CP08100BP	CABIN HOOK (100MM) CHROME	1	EA	10
276BR08100BP	CABIN HOOK (100MM) BRASS	1	EA	10
276SC08100BP	CABIN HOOK (100MM) S/CHROME	1	EA	10



CABIN HOOK - FORGED SOLID BRASS

Stainless Steel fixings supplied. 150mm length, 10mm rod.

For hook eye use code 276**E where ** indicates finish code. I.e. 276BRE

PRODUCT CODE	DESCRIPTION	QTY	PER	PCK
276FB10150BP	CABIN HOOK (150MM) BRONZE	1	EA	10
276CP10150BP	CABIN HOOK (150MM) CHROME	1	EA	10
276BR10150BP	CABIN HOOK (150MM) BRASS	1	EA	10
276SC10150BP	CABIN HOOK (150MM) S/CHROME	1	EA	10



CABIN HOOKS

CABIN HOOK - FORGED SOLID BRASS

Stainless Steel fixings supplied. 200mm length, 10mm rod.
For hook eye use code 276E where ** indicates finish code. I.e. 276BRE**

PRODUCT CODE	DESCRIPTION	QTY	PER	PCK
276FB10200BP	CABIN HOOK (200MM) BRONZE	1	EA	10
276CP10200BP	CABIN HOOK (200MM) CHROME	1	EA	10
276BR10200BP	CABIN HOOK (200MM) BRASS	1	EA	10
276SC10200BP	CABIN HOOK (200MM) S/CHROME	1	EA	10



CABIN HOOK - SOLID BRASS

Fixings supplied. 70mm length, 8mm rod.

PRODUCT CODE	DESCRIPTION	QTY	PER	PCK
476FB0870BP	CABIN HOOK (70MM) BRONZE	1	EA	10
476CP0870BP	CABIN HOOK (70MM) CHROME	1	EA	10
476BR0870BP	CABIN HOOK (70MM) BRASS	1	EA	10
476SC0870BP	CABIN HOOK (70MM) S/CHROME	1	EA	10



CABIN HOOK - SOLID BRASS

Fixings supplied. 80mm length, 8mm rod.

PRODUCT CODE	DESCRIPTION	QTY	PER	PCK
476FB0880BP	CABIN HOOK (80MM) BRONZE	1	EA	10
476CP0880BP	CABIN HOOK (80MM) CHROME	1	EA	10
476BR0880BP	CABIN HOOK (80MM) BRASS	1	EA	10
476SC0880BP	CABIN HOOK (80MM) S/CHROME	1	EA	10



CABIN HOOK - SOLID BRASS

Fixings supplied. 90mm length, 8mm rod.

PRODUCT CODE	DESCRIPTION	QTY	PER	PCK
476FB0890BP	CABIN HOOK (90MM) BRONZE	1	EA	10
476CP0890BP	CABIN HOOK (90MM) CHROME	1	EA	10
476BR0890BP	CABIN HOOK (90MM) BRASS	1	EA	10
476SC0890BP	CABIN HOOK (90MM) S/CHROME	1	EA	10



CABIN HOOK - STAINLESS STEEL

304 grade Stainless Steel
 Architectural quality, suitable for outdoor use. 10 year warranty.
For hook eye only use code 276SSE.

PRODUCT CODE	DESCRIPTION	QTY	PER	PCK
276SS100BP	CABIN HOOK (100MM) S/STEEL	1	EA	10
276SS150BP	CABIN HOOK (150MM) S/STEEL	1	EA	10



CABINET HARDWARE

ROLLER CATCH

Fixings supplied.

PRODUCT CODE	DESCRIPTION	QTY	PER	PCK
334ZC	ROLLER CATCH ZINC	1	EA	20
334ZCB	ROLLER CATCH (BULK 100 PK) ZINC	100	EA	1



CUPBOARD CATCH - ZINC

Fixings supplied.

PRODUCT CODE	DESCRIPTION	QTY	PER	PCK
099CP	CUPBOARD CATCH CHROME	1	EA	20



DOUBLE BALL CATCH - SOLID BRASS

Fixings supplied.
Adjustable tension.

PRODUCT CODE	DESCRIPTION	QTY	PER	PCK
708BR50	ROLLER CATCH (50MM) BRASS	1	EA	20
708BR60	ROLLER CATCH (60MM) BRASS	1	EA	20



GENERAL PURPOSE HANDLES - ZINC

Fixings supplied.

PRODUCT CODE	DESCRIPTION	QTY	PER	PCK
088FB114	BOW HANDLE (114MM) BRONZE	1	EA	10
088FB150	BOW HANDLE (150MM) BRONZE	1	EA	10
088CP114	BOW HANDLE (114MM) CHROME	1	EA	10
088CP150	BOW HANDLE (150MM) CHROME	1	EA	10
088SC114	BOW HANDLE (114MM) S/CHROME	1	EA	10
088SC150	BOW HANDLE (150MM) S/CHROME	1	EA	10



CONCAVE KNOB - ZINC

Fixings supplied.
Size: 38mm.

PRODUCT CODE	DESCRIPTION	QTY	PER	PCK
065CP38	CONCAVE KNOB CHROME	1	EA	10



CABINET HARDWARE

DRAWER HANDLE - SOLID BRASS

30mm length fixings supplied.
8mm rod size.

PRODUCT CODE	DESCRIPTION	QTY	PER	PCK
261FB0896	D HANDLE (96MM) BRONZE	1	EA	20
261CP0875	D HANDLE (75MM) CHROME	1	EA	20
261CP0896	D HANDLE (96MM) CHROME	1	EA	20
261SC0875	D HANDLE (75MM) S/CHROME	1	EA	20
261SC0896	D HANDLE (96MM) S/CHROME	1	EA	20



DRAWER HANDLE - SOLID BRASS

30mm length fixings supplied.
10mm rod size.

PRODUCT CODE	DESCRIPTION	QTY	PER	PCK
261CP1075	D HANDLE (75MM) CHROME	1	EA	20
261CP1096	D HANDLE (96MM) CHROME	1	EA	20
261SC1075	D HANDLE (75MM) S/CHROME	1	EA	20
261SC1096	D HANDLE (96MM) S/CHROME	1	EA	20
261CP10160	D HANDLE (160MM) CHROME	1	EA	20
261SC10160	D HANDLE (160MM) S/CHROME	1	EA	20



BOW HANDLE - ZINC ALLOY

Fixings supplied.
105mm length, 96mm hole centres.
148mm length, 128mm hole centres.

PRODUCT CODE	DESCRIPTION	QTY	PER	PCK
0651BN1005M	BOW HANDLE (105MM) S/NICKEL	1	EA	20
0651SC1005M	BOW HANDLE (105MM) S/CHROME	1	EA	20
0651BN1005L	BOW HANDLE (148MM) S/NICKEL	1	EA	20
0651SC1005L	BOW HANDLE (148MM) S/CHROME	1	EA	20



BOW HANDLE - ZINC ALLOY

Fixings supplied.
112mm length, 96mm hole centres.

PRODUCT CODE	DESCRIPTION	QTY	PER	PCK
0651BN1015M	BOW HANDLE (112MM) S/NICKEL	1	EA	20
0651SC1015M	BOW HANDLE (112MM) S/CHROME	1	EA	20



CABINET HARDWARE

BOW HANDLE – ZINC ALLOY

Fixings supplied.
151mm length, 128mm hole centres.

PRODUCT CODE	DESCRIPTION	QTY	PER	PCK
0651BN1015L	BOW HANDLE (151MM) S/NICKEL	1	EA	20
0651SC1015L	BOW HANDLE (151MM) S/CHROME	1	EA	20



BOW HANDLE – ZINC ALLOY

Fixings supplied.
113mm length, 96mm hole centres.

PRODUCT CODE	DESCRIPTION	QTY	PER	PCK
0651BN1211M	BOW HANDLE (113MM) S/NICKEL	1	EA	20
0651SC1211M	BOW HANDLE (113MM) S/CHROME	1	EA	20



BOW HANDLE – ZINC ALLOY

Fixings supplied.
142mm length, 128mm hole centres.

PRODUCT CODE	DESCRIPTION	QTY	PER	PCK
0651BN1211L	BOW HANDLE (142MM) S/NICKEL	1	EA	20
0651SC1211L	BOW HANDLE (142MM) S/CHROME	1	EA	20



BOW HANDLE – ZINC ALLOY

Fixings supplied.
179mm length, 128mm hole centres.

PRODUCT CODE	DESCRIPTION	QTY	PER	PCK
0651BN3126L	BOW HANDLE (179MM) S/NICKEL	1	EA	20
0651SC3126L	BOW HANDLE (179MM) S/CHROME	1	EA	20



BOW HANDLE – ZINC ALLOY

Fixings supplied.
142mm length, 128mm hole centres.

PRODUCT CODE	DESCRIPTION	QTY	PER	PCK
0651BN3076L	BOW HANDLE (142MM) S/NICKEL	1	EA	20
0651SC3076L	BOW HANDLE (142MM) S/CHROME	1	EA	20



CABINET HARDWARE

BOW HANDLE - ZINC

Fixings supplied.
137mm length, 128mm hole centres.

PRODUCT CODE	DESCRIPTION	QTY	PER	PCK
0651BN3129L	BOW HANDLE (137MM) S/NICKEL	1	EA	20
0651SC3129L	BOW HANDLE (137MM) S/CHROME	1	EA	20



BOW HANDLE – ZINC ALLOY

Fixings supplied.
160mm length, 128mm hole centres.

PRODUCT CODE	DESCRIPTION	QTY	PER	PCK
0651BN3009L	BOW HANDLE (160MM) S/NICKEL	1	EA	20
0651SC3009L	BOW HANDLE (160MM) S/CHROME	1	EA	20



BOW HANDLE – ZINC ALLOY

Fixings supplied.
200mm length, 128mm hole centres.

PRODUCT CODE	DESCRIPTION	QTY	PER	PCK
0651BN3047L	BOW HANDLE (200MM) S/NICKEL	1	EA	20
0651SC3047L	BOW HANDLE (200MM) S/CHROME	1	EA	20



SQUARE HANDLE – ZINC ALLOY

Fixings supplied.
131mm length, 128mm hole centres.

PRODUCT CODE	DESCRIPTION	QTY	PER	PCK
0651BN1092L	SQ. HANDLE (131MM) S/NICKEL	1	EA	20
0651SC1092L	SQ. HANDLE (131MM) S/CHROME	1	EA	20



SQUARE BAR HANDLE – ZINC ALLOY

Fixings supplied.
197mm length, 160mm hole centres.

PRODUCT CODE	DESCRIPTION	QTY	PER	PCK
0651BN3060XL	BAR HANDLE (197MM) S/NICKEL	1	EA	20
0651SC3060XL	BAR HANDLE (197MM) S/CHROME	1	EA	20



CABINET HARDWARE

SQUARE BAR HANDLE – ZINC ALLOY

Fixings supplied.
158mm length, 128mm hole centres.

PRODUCT CODE	DESCRIPTION	QTY	PER	PCK
0651BN3061L	BAR HANDLE (158MM) S/NICKEL	1	EA	20
0651SC3061L	BAR HANDLE (158MM) S/CHROME	1	EA	20



SQUARE HANDLE – ZINC ALLOY

Fixings supplied.
112mm length, 96mm hole centres.

PRODUCT CODE	DESCRIPTION	QTY	PER	PCK
0651BN1092M	SQ. HANDLE (112MM) S/NICKEL	1	EA	20
0651SC1092M	SQ. HANDLE (112MM) S/CHROME	1	EA	20



SQUARE BAR HANDLE – ZINC ALLOY

Fixings supplied.
119mm length, 96mm hole centres.

PRODUCT CODE	DESCRIPTION	QTY	PER	PCK
0651BN3064M	SQ. HANDLE (119MM) S/NICKEL	1	EA	20
0651SC3064M	SQ. HANDLE (119MM) S/CHROME	1	EA	20



SQUARE BAR HANDLE – ZINC ALLOY

Fixings supplied.
155mm length, 128mm hole centres.

PRODUCT CODE	DESCRIPTION	QTY	PER	PCK
0651BN3064L	SQ. HANDLE (155MM) S/NICKEL	1	EA	20
0651SC3064L	SQ. HANDLE (155MM) S/CHROME	1	EA	20

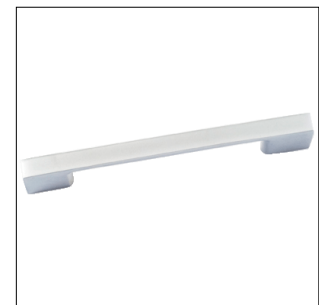

SQUARE BAR HANDLE – ZINC ALLOY

Fixings supplied.
108mm length, 96mm hole centres.

PRODUCT CODE	DESCRIPTION	QTY	PER	PCK
0651BN4019M	BAR HANDLE (108MM) S/NICKEL	1	EA	20
0651SC4019M	BAR HANDLE (108MM) S/CHROME	1	EA	20

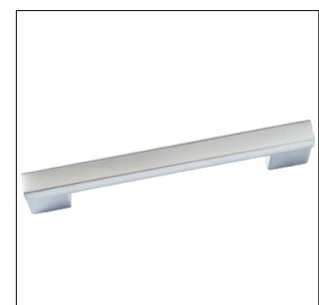

CABINET HARDWARE

SQUARE BAR HANDLE – ZINC ALLOY

Fixings supplied.
140mm length, 128mm hole centres.

PRODUCT CODE	DESCRIPTION	QTY	PER	PCK
0651BN4019L	BAR HANDLE (140MM) S/NICKEL	1	EA	20
0651SC4019L	BAR HANDLE (140MM) S/CHROME	1	EA	20



ROUND BAR HANDLE – STAINLESS STEEL

Fixings supplied.
155mm length, 96mm hole centres.

PRODUCT CODE	DESCRIPTION	QTY	PER	PCK
0651BN2001155M	BAR HANDLE (155MM) S/NICKEL	1	EA	20
0651SC2001155M	BAR HANDLE (155MM) S/CHROME	1	EA	20



ROUND BAR HANDLE – STAINLESS STEEL

Fixings supplied.
200mm length, 128mm hole centres.

PRODUCT CODE	DESCRIPTION	QTY	PER	PCK
0651BN2001200L	BAR HANDLE (200MM) S/NICKEL	1	EA	20
0651SC2001200L	BAR HANDLE (200MM) S/CHROME	1	EA	20



KNOB HANDLE – ZINC ALLOY

Fixings supplied.
25mm diameter.

PRODUCT CODE	DESCRIPTION	QTY	PER	PCK
0651BN1160L	KNOB HANDLE (25MM) S/NICKEL	1	EA	20
0651SC1160L	KNOB HANDLE (25MM) S/CHROME	1	EA	20



KNOB HANDLE – ZINC ALLOY

Fixings supplied.
24mm diameter.

PRODUCT CODE	DESCRIPTION	QTY	PER	PCK
0651BN1165	KNOB HANDLE (24MM) S/NICKEL	1	EA	20
0651SC1165	KNOB HANDLE (24MM) S/CHROME	1	EA	20



CABINET HARDWARE

KNOB HANDLE – ZINC ALLOY

Fixings supplied.
29mm diameter.

PRODUCT CODE	DESCRIPTION	QTY	PER	PCK
0651BN1165	KNOB HANDLE (24MM) S/NICKEL	1	EA	20
0651SC1165	KNOB HANDLE (24MM) S/CHROME	1	EA	20



KNOB HANDLE – ZINC ALLOY

Fixings supplied.
22mm diameter.

PRODUCT CODE	DESCRIPTION	QTY	PER	PCK
0651BN1179	KNOB HANDLE (22MM) S/NICKEL	1	EA	20
0651SC1179	KNOB HANDLE (22MM) S/CHROME	1	EA	20



KNOB HANDLE – ZINC ALLOY

Fixings supplied.
17mm diameter.

PRODUCT CODE	DESCRIPTION	QTY	PER	PCK
0651BN1160	KNOB HANDLE (17MM) S/NICKEL	1	EA	20
0651SC1160	KNOB HANDLE (17MM) S/CHROME	1	EA	20



KNOB HANDLE – ZINC ALLOY

Fixings supplied.
14mm diameter.

PRODUCT CODE	DESCRIPTION	QTY	PER	PCK
0651BN1172L	KNOB HANDLE (14MM) S/NICKEL	1	EA	20
0651SC1172L	KNOB HANDLE (14MM) S/CHROME	1	EA	20



KNOB HANDLE – ZINC ALLOY

Fixings supplied.
11mm diameter.

PRODUCT CODE	DESCRIPTION	QTY	PER	PCK
0651BN1172	KNOB HANDLE (11MM) S/NICKEL	1	EA	20
0651SC1172	KNOB HANDLE (11MM) S/CHROME	1	EA	20



CABINET HARDWARE

KNOB HANDLE – ZINC ALLOY

Fixings supplied.
19mm diameter.

PRODUCT CODE	DESCRIPTION	QTY	PER	PCK
0651BN1114	KNOB HANDLE (19MM) S/NICKEL	1	EA	20
0651SC1114	KNOB HANDLE (19MM) S/CHROME	1	EA	20



FINGER PULL HANDLE – ZINC ALLOY

Fixings supplied.
15mm x 14mm.

PRODUCT CODE	DESCRIPTION	QTY	PER	PCK
0651BN3590	PULL HANDLE (15MM) S/NICKEL	1	EA	20
0651SC3590	PULL HANDLE (15MM) S/CHROME	1	EA	20



FINGER PULL HANDLE – ZINC ALLOY

Fixings supplied.
25mm x 25mm.

PRODUCT CODE	DESCRIPTION	QTY	PER	PCK
0651BN1112	PULL HANDLE (25MM) S/NICKEL	1	EA	20
0651SC1112	PULL HANDLE (25MM) S/CHROME	1	EA	20



FINGER PULL HANDLE – ZINC ALLOY

Fixings supplied.
56mm length, 32mm hole centres.

PRODUCT CODE	DESCRIPTION	QTY	PER	PCK
0651BN1187	PULL HANDLE (56MM) S/NICKEL	1	EA	20
0651SC1187	PULL HANDLE (56MM) S/CHROME	1	EA	20



FINGER PULL HANDLE – ZINC ALLOY

Fixings supplied.
41mm length, 32mm hole centres.

PRODUCT CODE	DESCRIPTION	QTY	PER	PCK
0651BN1299	PULL HANDLE (41MM) S/NICKEL	1	EA	20
0651SC1299	PULL HANDLE (41MM) S/CHROME	1	EA	20



CABINET HARDWARE

FINGER PULL HANDLE – ZINC ALLOY

Fixings supplied.
35mm x 8mm.

PRODUCT CODE	DESCRIPTION	QTY	PER	PCK
0651BN1164	PULL HANDLE (35MM) S/NICKEL	1	EA	20
0651SC1164	PULL HANDLE (35MM) S/CHROME	1	EA	20

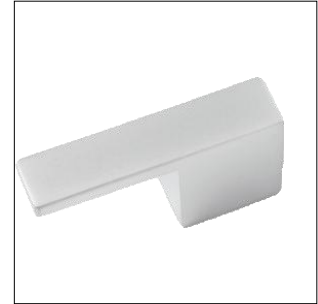

KNOB HANDLE – ZINC ALLOY

Fixings supplied.
20mm x 21mm.

PRODUCT CODE	DESCRIPTION	QTY	PER	PCK
0651BN1194	PULL HANDLE (21MM) S/NICKEL	1	EA	20
0651SC1194	PULL HANDLE (21MM) S/CHROME	1	EA	20



FINGER PULL HANDLE – ZINC ALLOY

Fixings supplied.
32mm hole centres.

PRODUCT CODE	DESCRIPTION	QTY	PER	PCK
0651BN1168	KNOB HANDLE (32MM) S/NICKEL	1	EA	20
0651SC1168	KNOB HANDLE (32MM) S/CHROME	1	EA	20



DOOR FITTINGS

FLUSH NECKED BOLT – FORGED SOLID BRASS

Fixings supplied, one piece extrusion, suitable for bifold, sliding & hinged doors.
100mm throw size: 38mm, 150mm throw size: 25mm.
8mm neck offset: 6mm, 10mm neck offset: 11mm

PRODUCT CODE	DESCRIPTION	QTY	PER	PCK
216BR08100	FLUSH BOLT (100MM) BRASS	1	EA	10
216BR10150	FLUSH BOLT (150MM) BRASS	1	EA	10
216SC08100	FLUSH BOLT (100MM) S/CHROME	1	EA	10
216SC10150	FLUSH BOLT (150MM) S/CHROME	1	EA	10



FLUSH SLIDE BOLT – FORGED SOLID BRASS

Fixings supplied, one piece extrusion, suitable for bifold, sliding & hinged doors.
100mm throw size: 38mm, 150mm throw size: 25mm.
8mm neck offset: 6mm, 10mm neck offset: 11mm

PRODUCT CODE	DESCRIPTION	QTY	PER	PCK
215BR08100	SLIDE BOLT (100MM) BRASS	1	EA	10
215BR10150	SLIDE BOLT (150MM) BRASS	1	EA	10
215SC08100	SLIDE BOLT (100MM) S/CHROME	1	EA	10
215SC10150	SLIDE BOLT (150MM) S/CHROME	1	EA	10



FLUSH BOLT – FORGED SOLID BRASS

Fixings supplied.
Available in brushed Satin Chrome & Brass finishes.
Size: 150mm x 19mm, 18mm throw, 18.5mm depth.

PRODUCT CODE	DESCRIPTION	QTY	PER	PCK
711BR	FLUSH BOLT (150MM) BRASS	1	EA	10
711SC	FLUSH BOLT (150MM) S/CHROME	1	EA	10



FLUSH BOLT – FORGED SOLID BRASS

Fixings supplied, heavy duty.
Available in brushed Satin Chrome & Satin Nickel finishes.
Size: 150mm x 19mm, 18mm throw, 18.5mm depth.

PRODUCT CODE	DESCRIPTION	QTY	PER	PCK
305SC150	FLUSH BOLT (150MM) S/CHROME	1	EA	10
305SN150	FLUSH BOLT (150MM) S/NICKEL	1	EA	10



DOOR FITTINGS

DUST SOCKET - SOLID BRASS

Length 40mm, diameter 19mm.
Fits 12mm diameter bolts.
Suits 711, 215, 216 & 305 series of flush bolts.

PRODUCT CODE	DESCRIPTION	QTY	PER	PCK
706SC	DUST SOCKET SATIN CHROME	1	EA	10



DUST SOCKET – SOLID BRASS

Overall length 47mm, flange diameter 43mm, socket diameter 21mm.
Suits 711, 215, 216 & 305 series of flush bolts.
214SC/SN has exposed fixings for going into timber.
314SC has no fixing holes for going into concrete (as pictured).

PRODUCT CODE	DESCRIPTION	QTY	PER	PCK
214SC	DUST SOCKET SATIN CHROME	1	EA	10
215SN	DUST SOCKET SATIN NICKEL	1	EA	10
314SC	DUST SOCKET SATIN CHROME	1	EA	10



INDICATOR BOLTS

Fixings supplied.
Suits door thickness 28mm-45mm
Stainless Steel & Zinc Diecast options.

PRODUCT CODE	DESCRIPTION	QTY	PER	PCK
3065SC	INDICATOR BOLT SATIN CHROME	1	EA	10
710SS	INDICATOR BOLT S/STEEL	1	EA	10



DOOR GUARD

Fixings supplied.
Available in Brass & Satin Chrome finishes.

PRODUCT CODE	DESCRIPTION	QTY	PER	PCK
707BR	DOOR GUARD BRASS PLATED	1	EA	10
707SC	DOOR GUARD SATIN CHROME	1	EA	10



DOOR VIEWER SOLID BRASS

200 degree viewing angle.
Suits doors 36mm to 60mm.

PRODUCT CODE	DESCRIPTION	QTY	PER	PCK
709BR	DOOR VIEWER BRASS	1	EA	10
709SC	DOOR VIEWER S/CHROME	1	EA	10



DOOR FITTINGS

ROLLER CATCH

Fixings supplied.
Adjustable brass roller.
Finish indicates striker plate colour.

PRODUCT CODE	DESCRIPTION	QTY	PER	PCK
333BR	ROLLER CATCH BRASS	1	EA	10
333SC	ROLLER CATCH SATIN CHROME	1	EA	10
333SCB	ROLLER CATCH BULK S/CHROME	50	EA	1

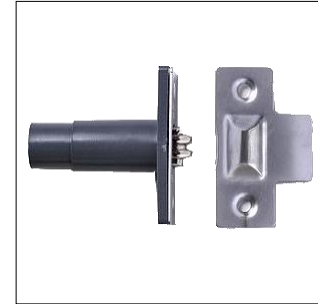

DOOR MAGNETS

Countersunk fixings supplied. (See fitting instructions below)
Size: 22mm x 8mm.
Magnet concealers supplied with 4 packs.

PRODUCT CODE	DESCRIPTION	QTY	PER	PCK
332CP	DOOR MAGNETS (PAIR)	1	EA	20
332CPB	DOOR MAGNETS (BULK)	50	EA	1
332CP4	DOOR MAGNET 4 PACK	4	EA	1

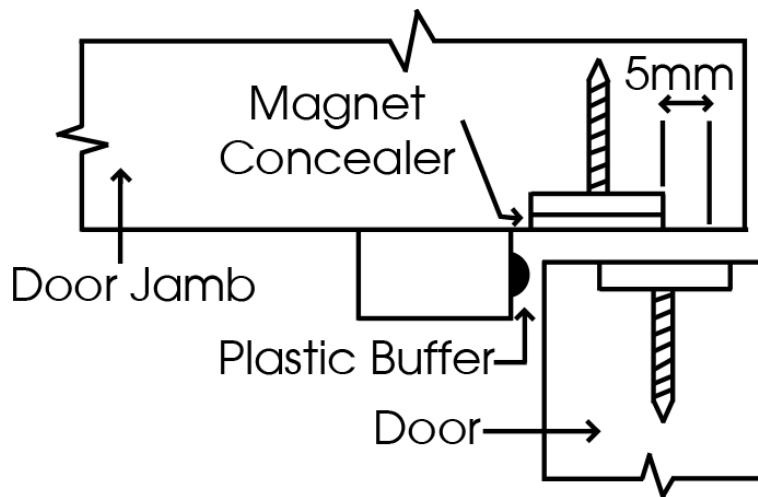

MORTICE REBATE KIT SATIN NICKEL

For wooden doors.
Fits both right and left handed doors with a 12.5mm rebate.
Quality construction. Easy to install.
Fixings supplied.
Suitable for use with 5 lever mortice locks and Euro and Fortress mortice locks only.

PRODUCT CODE	DESCRIPTION	QTY	PER	PCK
716SN12	MORTICE REBATE KIT S/NICKEL	1	EA	5



DOOR FITTINGS

REBATE KIT

Suit 715, 716, 728 & 729 mortice locks.
 Fixings supplied. Reversible
 Satin Nickel bracket, Stainless Steel striker.

PRODUCT CODE	DESCRIPTION	QTY	PER	PCK
720SS (SUITS 715,716)	REBATE KIT STAINLESS STEEL	1	EA	10
720BR (SUITS 715,716)	REBATE KIT BRASS	1	EA	10
727SS (SUITS 728,729)	REBATE KIT STAINLESS STEEL	1	EA	10

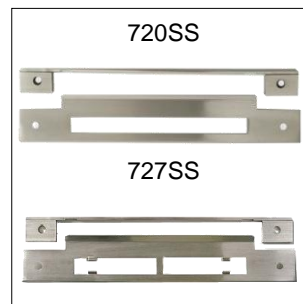

REBATE KIT

Installation of latch for rebated doors (single or pairs).
 Note that the rebated section of the doors must be exactly 12.5mm deep.
 Fixings supplied

PRODUCT CODE	DESCRIPTION	QTY	PER	PCK
291BR	REBATE KIT BRASS	1	EA	10
291CP	REBATE KIT CHROME	1	EA	10
291SC	REBATE KIT SATIN CHROME	1	EA	10
291FB	REBATE KIT BRONZE	1	EA	10



TUBULAR LATCH - STAINLESS STEEL

Stainless Steel face plate and strike.
 Size: 60mm backset only, 7.5mm spindle hole.

PRODUCT CODE	DESCRIPTION	QTY	PER	PCK
9860SS	TUBULAR LATCH 60MM S/STEEL	1	EA	10



TUBULAR LATCH

Designed by Miles Nelson

Suitable for through door fixing handles with 38mm - 41mm centres
 Fixings supplied, tested to 200,000 cycles.
 Size: 60mm backset, 8mm spindle hole.
 Reduced lever movement to open.

PRODUCT CODE	DESCRIPTION	QTY	PER	PCK
415SN60	TUBULAR LATCH NICKEL PLATED	1	EA	20
415SS60	TUBULAR LATCH S/STEEL	1	EA	20



DOOR FITTINGS

FORTRESS EURO MORTICE LOCKS

Anti drill casing. Reversible sash bolt. Closed case.
For wooden doors. Through door centres, 38mm.
4 revolving steel rollers, for high level security
D.I.Y. friendly installation. Made to British standards BS5872.
Available in 45mm and 58mm backset options. 8mm spindle.

PRODUCT CODE	DESCRIPTION	QTY	PER	PCK
716SN45F	F. EURO MORTICE LOCK (45MM)	1	EA	5
716SN58F	F. EURO MORTICE LOCK (58MM)	1	EA	5



MORTICE LOCK 3 LEVER

Slimline design. One turn of the key dead locks the door. Closed case.
Used in conjunction with a door handle, the lock has a sprung latch which catches as the door closes, as well as the dead bolt lock.
Fixings supplied. Through door centres, 38mm.
Size: 45mm backset or 58mm backset lock. 8mm spindle.

PRODUCT CODE	DESCRIPTION	QTY	PER	PCK
716SSN663	3 LEVER MORTICE LOCK (45MM)	1	EA	5
716SSN763	3 LEVER MORTICE LOCK (58MM)	1	EA	5

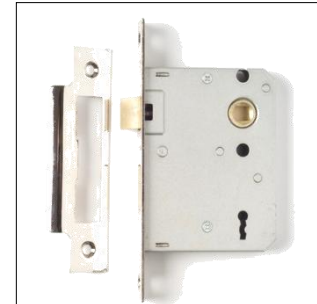

MORTICE LOCK 5 LEVER

Slimline design with anti saw rollers. Closed case.
One turn of the key dead locks the door. Through door centres, 38mm.
Used in conjunction with a door handle, the lock has a sprung latch which catches as the door closes, as well as the dead bolt lock.
Made to British standards BS5872. Fixings supplied.
Size: 45mm backset or 58mm backset lock. 8mm spindle.

PRODUCT CODE	DESCRIPTION	QTY	PER	PCK
716SN665	5 LEVER MORTICE LOCK (45MM)	1	EA	5
716SN765	5 LEVER MORTICE LOCK (58MM)	1	EA	5



EURO MORTICE LOCK

Slimline design. Anti saw rollers
Reversible sash bolt. Through door centres, 38mm.
Certified to British standards
D.I.Y. friendly installation
Available in 45mm and 58mm backset options. 8mm spindle.

PRODUCT CODE	DESCRIPTION	QTY	PER	PCK
716SN45	EURO MORTICE LOCK (45MM)	1	EA	5
716SN58	EURO MORTICE LOCK (58MM)	1	EA	5

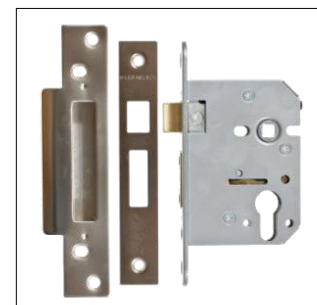

DOOR FITTINGS

EURO MORTICE LOCK

Reversible latch, key operated latch. Double action dead bolt, closed case. Suits 38mm - 42mm through door furniture, fixings supplied. Backset 45mm and 60mm. C/C 85mm. 8mm spindle hole.

PRODUCT CODE	DESCRIPTION	QTY	PER	PCK
716BR45	MORTICE LOCK (45MM) BRASS	1	EA	10
716BR60	MORTICE LOCK (60MM) BRASS	1	EA	10
716SS45	MORTICE LOCK (45MM) S/STEEL	1	EA	10
716SS60	MORTICE LOCK (60MM) S/STEEL	1	EA	10



EURO ROLLER LOCK

Double action dead bolt. Closed case & Adjustable roller. Supplied with left and right hand strikers - **Designed by Miles Nelson.** Suits 38 – 42mm through door furniture. Fixings supplied. **Stainless Steel** face and strike plates. 60mm backset.

PRODUCT CODE	DESCRIPTION	QTY	PER	PCK
728SS60	ROLLER LOCK (60MM)	1	EA	1



ROLLER LOCK KIT

Kit includes:

- 728SS60 Euro Roller Lock.
- 717SC65KD Euro Cylinder & Turn.
- 636SSBP Euro Escutcheon.

Keyed different. Supplied with three keys. Fixings supplied. 60mm backset.

PRODUCT CODE	DESCRIPTION	QTY	PER	PCK
729SS	LOCK KIT (60MM) S/STEEL	1	EA	1



MORTICE LOCK KIT

Kit includes;

- 716 Euro Mortice Lock.
- 717SC65KD Euro Cylinder & Turn.
- 636SSBP Euro Escutcheon.

Keyed different. Supplied with three keys. Fixings supplied. 60mm backset.

PRODUCT CODE	DESCRIPTION	QTY	PER	PCK
715SN	LOCK KIT (60MM) S/STEEL	1	EA	1



PULL HANDLE LOCK KITS

Provides a secure latch with turns both sides for doors with pull. Suits areas where roller latch is not strong enough to hold doors. Kits Include:

- 716SS60 Mortise lock (de-sprung) 60mm b/s
- 716SSS (Square) OR 716SSR (Round) finger turns
- 716SSSES (Square) OR 716SSSER (Round) escutcheons

Square or round kits, cylinder options sold separately, see following 2 pages.

PRODUCT CODE	DESCRIPTION	QTY	PER	PCK
716SSSLK60	SQUARE PULL HANDLE LOCK KIT	1	EA	1
716SSRLK60	ROUND PULL HANDLE LOCK KIT	1	EA	1



DOOR FITTINGS

MORTICE LOCK ACRYLIC PACKER

To suit 716 series mortice locks
Used when fitting to aluminium

PRODUCT CODE	DESCRIPTION	QTY	PER	PCK
716-728S8	ACRYLIC SPACER 8MM	1	EA	10
716-728S10	ACRYLIC SPACER 10MM	1	EA	10



SQUARE ESCUTCHEON - STAINLESS STEEL 304 (PAIR)

Secured onto cylinder with grub screw.

Size: 50mm x 50mm

PRODUCT CODE	DESCRIPTION	QTY	PER	PCK
780SSBP	ESCUTCHEON (50MM) S/STEEL	1	EA	10



EURO ESCUTCHEON - STAINLESS STEEL 304 (PAIR)

Screw fixings concealed by cover over plate.

Size: 52mm diameter

PRODUCT CODE	DESCRIPTION	QTY	PER	PCK
636SSBP	ESCUTCHEON (52MM) S/STEEL	1	EA	10



EURO ESCUTCHEON - ZINC

Screw fixings concealed by cover plate.

Oval and Euro profile. Screw on cover plates.

Size: 52mm.

Satin Nickel finish.

PRODUCT CODE	DESCRIPTION	QTY	PER	PCK
987008SN	ESCUTCHEON (OVAL) S/NICKEL	1	EA	10
987010SN	ESCUTCHEON (EURO) S/NICKEL	1	EA	10



EURO CYLINDER & TURN - SOLID BRASS

C4 keyway. **Keyed alike.**

Supplied with 3 keys.

5 pin, 65mm long cylinder.

PRODUCT CODE	DESCRIPTION	QTY	PER	PCK
717BR65KA10	CYLINDER AND TURN BRASS	1	EA	20
717SC65KA10	CYLINDER AND TURN S/CHROME	1	EA	20
717SN65KA10	CYLINDER AND TURN S/NICKEL	1	EA	20



DOOR FITTINGS

EURO CYLINDER & TURN - SOLID BRASS

C4 keyway. **Keyed different.**
 Supplied with 3 keys.
 5 pin, 65mm long cylinder.

PRODUCT CODE	DESCRIPTION	QTY	PER	PCK
717BR65KD	CYLINDER AND TURN BRASS	1	EA	20
717SC65KD	CYLINDER AND TURN S/CHROME	1	EA	20



EURO DOUBLE CYLINDER

C4 keyway. **Keyed alike.**
 Supplied with 3 keys.
 5 pin, 65mm long cylinder.

PRODUCT CODE	DESCRIPTION	QTY	PER	PCK
718SC65KA10	DOUBLE CYLINDER S/CHROME	1	EA	20
718SN65KA10	DOUBLE CYLINDER S/NICKEL	1	EA	20



EURO DOUBLE CYLINDER

C4 keyway. **Keyed different.**
 Supplied with 3 keys.
 5 pin, 65mm long cylinder.

PRODUCT CODE	DESCRIPTION	QTY	PER	PCK
718SC65KD	DOUBLE CYLINDER S/CHROME	1	EA	20
718SN65KD	DOUBLE CYLINDER S/NICKEL	1	EA	20



PRIVACY TURN AND BOLT - BRUSHED STAINLESS STEEL

Supplied with a 60mm privacy bolt. Fixings supplied.
 Round profile.
 Size: 52mm rose

PRODUCT CODE	DESCRIPTION	QTY	PER	PCK
635SSBP	PRIVACY TURN & BOLT S/STEEL	1	EA	10



PRIVACY TURN AND BOLT - BRUSHED STAINLESS STEEL

Supplied with a 60mm privacy bolt. Fixings supplied.
 Square profile.
 Size: 52mm diameter rose.

PRODUCT CODE	DESCRIPTION	QTY	PER	PCK
698SS	PRIVACY TURN & BOLT S/STEEL	1	EA	10



DOOR FITTINGS

PRIVACY HARDWARE

Fixings supplied.
Size: 52mm Rose.

PRODUCT CODE	DESCRIPTION	QTY	PER	PCK
987009SN	EMERGENCY RELEASE S/NICKEL	1	EA	10
987007SN	PRIVACY TURN S/NICKEL	1	EA	10
9801SS	PRIVACY BOLT STAINLESS STEEL	1	EA	10
9802SS	COMPLETE PRIVACY KIT	1	EA	1



FLUSH PULL - ZINC

Fixings supplied.
Size: 34mm x 100mm.

PRODUCT CODE	DESCRIPTION	QTY	PER	PCK
106FB100	FLUSH PULL (100MM) BRONZE	1	EA	10
106CP100	FLUSH PULL (100MM) CHROME	1	EA	10
106SC100	FLUSH PULL (100MM) S/CHROME	1	EA	10
106GD100	FLUSH PULL (100MM) GOLD	1	EA	10
106PW100	FLUSH PULL (100MM) WHITE	1	EA	10



FLUSH PULL - ZINC

Fixings supplied.
Size: 34mm x 140mm.

PRODUCT CODE	DESCRIPTION	QTY	PER	PCK
106FB140	FLUSH PULL (140MM) BRONZE	1	EA	10
106CP140	FLUSH PULL (140MM) CHROME	1	EA	10
106SC140	FLUSH PULL (140MM) S/CHROME	1	EA	10
106GD140	FLUSH PULL (140MM) GOLD	1	EA	10



FLUSH CAVITY PULLS

Fixings supplied.
Suits door thickness 32mm-36mm.
Passage and privacy options.

PRODUCT CODE	DESCRIPTION	QTY	PER	PCK
746SC	PRIVACY CAVITY PULL S/CHROME	1	EA	10
747SC	PASSAGE CAVITY PULL S/CHROME	1	EA	10



DOOR FITTINGS

ROUND FLUSH PULL - BRUSHED STAINLESS STEEL 304

To be glued into same size diameter hole.

Size: 30, 40 and 50mm flange (outside diameter).

Cut out size: 30mm = 26mm, 40mm = 35mm, 50mm = 40mm

PRODUCT CODE	DESCRIPTION	QTY	PER	PCK
744SC30	FLUSH PULL (30MM) S/CHROME	1	EA	20
744SC40	FLUSH PULL (40MM) S/CHROME	1	EA	20
744SC50	FLUSH PULL (50MM) S/CHROME	1	EA	20



FLUSH PULL OVAL - BRUSHED STAINLESS STEEL 304

Fixings supplied.

Size: 120mm x 40mm.

Face fixed or concealed fixing options.

PRODUCT CODE	DESCRIPTION	QTY	PER	PCK
712SS	FACE FIX FLUSH PULL S/STEEL	1	EA	10
732SS	CONC. FIX FLUSH PULL S/STEEL	1	EA	10



FLUSH PULL SQUARE - BRUSHED STAINLESS STEEL 304

Fixings supplied.

Size: 34mm x 140mm.

Face fixed or concealed fixing options.

PRODUCT CODE	DESCRIPTION	QTY	PER	PCK
713SS	FACE FIX FLUSH PULL S/STEEL	1	EA	10
733SS	CONC. FIX FLUSH PULL S/STEEL	1	EA	10



FINGER PULLS - BRUSHED STAINLESS STEEL 304

For cavity door edges and cupboard doors.

To be glued into same size diameter hole.

Size: 26mm diameter cut out.

PRODUCT CODE	DESCRIPTION	QTY	PER	PCK
748SS26	SQUARE FINGER PULL (26MM)	1	EA	10
749SS26	ROUND FINGER PULL (26MM)	1	EA	10



ROUND FINGER PULL - BRUSHED STAINLESS STEEL 304

To be glued into same size diameter hole.

Size: 90mm flange (outside diameter).

Cut out size: 70mm

PRODUCT CODE	DESCRIPTION	QTY	PER	PCK
745SS90	ROUND FLUSH PULL S/STEEL	1	EA	10



DOOR FITTINGS

RECTANGLE FLUSH PULL - BRUSHED STAINLESS STEEL 304

Concealed fixings.
Supplied with screws.
Size: 120mm x 40mm, 15mm depth.

PRODUCT CODE	DESCRIPTION	QTY	PER	PCK
981120SS	RECTANGLE FLUSH PULL S/STEEL	1	EA	1



RECTANGLE FLUSH PULL - BRUSHED STAINLESS STEEL 304

Concealed fixings.
Supplied with screws.
Size: 240mm x 40mm, 15mm depth.

PRODUCT CODE	DESCRIPTION	QTY	PER	PCK
9811240SS	RECTANGLE FLUSH PULL S/STEEL	1	EA	10



SQUARE FLUSH PULL KIT - STAINLESS STEEL 304

Fixings supplied.
Complete cavity slider handle solution.
Concealed fixings.

Size: Door Pull 120mm x 42mm, 15mm depth.
Finger Pull 30mm, 25mm depth.

PRODUCT CODE	DESCRIPTION	QTY	PER	PCK
222SS	FLUSH PULL KIT S/STEEL	1	EA	5

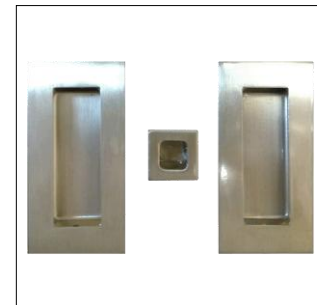

ROUND FLUSH PULL KIT - STAINLESS STEEL 304

Fixings supplied.
Complete cavity slider handle solution.
Concealed fixings.

Size: Door Pull 120mm x 42mm, 15mm depth.
Finger Pull 30mm, 25mm depth.

PRODUCT CODE	DESCRIPTION	QTY	PER	PCK
224SS	ROUND FLUSH PULL KIT S/STEEL	1	EA	10



SQUARE LOCKING FLUSH PULL KIT - SATIN NICKEL

Fixings supplied.
Complete privacy sliding door solution.
Through door fixing.
Size: Door Pull 150mm x 45mm
Finger Pull 26mm x 26mm

PRODUCT CODE	DESCRIPTION	QTY	PER	PCK
227SN	FLUSH PULL KIT SATIN NICKEL	1	EA	10



DOOR FITTINGS

ROUND LOCKING FLUSH PULL KIT - STAINLESS STEEL 304

Fixings supplied.
Complete privacy sliding door solution.
Through door fixing.
Size: Door Pull 125mm x 45mm
Finger Pull 30mm

Note: turn knob protrudes 5mm for recessing doors use **227SN**

PRODUCT CODE	DESCRIPTION	QTY	PER	PCK
228SS	FLUSH PULL KIT S/STEEL	1	EA	5



DEADBOLTS - BRUSHED STAINLESS STEEL 304

Suitable for light commercial applications.
Suits door thickness 42-51mm.
Interchangeable core.
6 pin euro keyway. Master keyable.

PRODUCT CODE	DESCRIPTION	QTY	PER	PCK
983615SS	DEADBOLT KEY & TURN S/S	1	EA	1
983620SS	DEADBOLT KEY & KEY S/S	1	EA	1



FRENCH DOOR FASTENER - FORGED BRASS

Fixings supplied.

PRODUCT CODE	DESCRIPTION	QTY	PER	PCK
475BR	F/DOOR FASTENER BRASS	1	EA	5
475CP	F/DOOR FASTENER CHROME	1	EA	5
475SC	F/DOOR FASTENER S/CHROME	1	EA	5
475FB	F/DOOR FASTENER BRONZE	1	EA	5



SLIM KNOCKER - SOLID BRASS

Fixings supplied.

PRODUCT CODE	DESCRIPTION	QTY	PER	PCK
48BR3033	DOOR KNOCKER SLIM BRASS	1	EA	1
48CP3033	DOOR KNOCKER SLIM CHROME	1	EA	1



EDWARDIAN KNOCKER - SOLID BRASS

Fixings supplied.

PRODUCT CODE	DESCRIPTION	QTY	PER	PCK
48BR3034	DOOR KNOCKER BRASS	1	EA	1
48CP3034	DOOR KNOCKER CHROME	1	EA	1



DOOR HANDLES

AXIS PULL HANDLE - BRUSHED STAINLESS STEEL

Architectural quality, tubular stainless steel 304.
 Suitable for timber, glass and aluminium doors
 Through door fixing. Fixings supplied. Door thickness 40 – 52mm.
 Roller latch set, use 729SS (supplied separately see page 32)
 Lock set use 716SSRLK60 (supplied separately see page 32)
 Sizes: 600mm (400mm C/C) and 450mm (250mm C/C).

PRODUCT CODE	DESCRIPTION	QTY	PER	PCK
629SS450 (PAIR)	PULL HANDLES (450MM) S/STEEL	1	EA	1
629PS450 (PAIR)	PULL HANDLES (450MM) P/STEEL	1	EA	1
629SS600 (PAIR)	PULL HANDLES (600MM) S/STEEL	1	EA	1



AXIS PULL HANDLE - BRUSHED STAINLESS STEEL

Architectural quality, tubular stainless steel 304.
 Suitable for timber, glass and aluminium doors
 Through door fixing. Fixings supplied. Door thickness 40 – 52mm.
 Roller latch set, use 729SS (supplied separately see page 32)
 Lock set use 716SSRLK60 (supplied separately see page 32)
 Sizes: 600mm (400mm C/C) and 450mm (250mm C/C).

PRODUCT CODE	DESCRIPTION	QTY	PER	PCK
628SS450 (SINGLE)	PULL HANDLE (450MM) S/STEEL	1	EA	1
628PS450 (SINGLE)	PULL HANDLE (450MM) P/STEEL	1	EA	1
628SS600 (SINGLE)	PULL HANDLE (600MM) S/STEEL	1	EA	1



ASSO PULL HANDLE - BRUSHED STAINLESS STEEL

Architectural quality, tubular stainless steel 304.
 Suitable for timber, glass and aluminium doors
 Through door fixing. Fixings supplied. Door thickness 40 – 52mm.
 Roller latch set, use 729SS (supplied separately see page 32)
 Lock set use 716SSRLK60 (supplied separately see page 32)
 Size: 610mm (286mm C/C)

PRODUCT CODE	DESCRIPTION	QTY	PER	PCK
750SS610 (PAIR)	PULL HANDLES (610MM) S/STEEL	1	EA	1

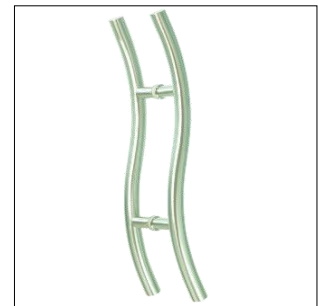

BALMORAL PULL HANDLE - SOLID STAINLESS STEEL

Architectural quality, solid stainless steel 304.
 Suitable for timber, glass and aluminium doors
 Through door fixing. Fixings supplied. Door thickness 38 – 52mm.
 Roller latch set, use 729SS (supplied separately see page 32)
 Lock set use 716SSSLK60 (supplied separately see page 32)
 Size: 347mm (250mm C/C)

PRODUCT CODE	DESCRIPTION	QTY	PER	PCK
753SS (PAIR)	PULL HANDLES (347MM) S/STEEL	1	EA	1



DOOR HANDLES

QUAD PULL HANDLE - BRUSHED STAINLESS STEEL

Architectural quality, tubular stainless steel 304.
 Suitable for timber, glass and aluminium doors.
 Through door fixing. Fixings supplied. Door thickness 40 – 52mm.
 Roller latch set, use 729SS (supplied separately see page 32)
 Lock set use 716SSSLK60 (supplied separately see page 32)
 Sizes: 600mm (562mm C/C) 38mm tube.

PRODUCT CODE	DESCRIPTION	QTY	PER	PCK
755SS (PAIR)	PULL HANDLES (600MM) S/STEEL	1	EA	1



CEE PULL HANDLE - BRUSHED STAINLESS STEEL

Architectural quality, tubular stainless steel 304.
 Suitable for timber, glass and aluminium doors
 Through door fixing. Fixings supplied. Door thickness 40 – 52mm.
 Roller latch set, use 729SS (supplied separately see page 32)
 Lock set use 716SSRLK60 (supplied separately see page 32)
 Sizes: 500mm (433mm C/C) 32mm tube.

PRODUCT CODE	DESCRIPTION	QTY	PER	PCK
756SS (PAIR)	PULL HANDLES (500MM) S/STEEL	1	EA	1



ARCO PULL HANDLE - BRUSHED STAINLESS STEEL

Architectural quality, tubular stainless steel 304.
 Suitable for timber, glass and aluminium doors
 Through door fixing. Fixings supplied. Door thickness 40 – 52mm.
 Roller latch set, use 729SS (supplied separately see page 32)
 Lock set use 716SSRLK60 (supplied separately see page 32)
 Size: 610mm (578mm C/C) 32mm tube

PRODUCT CODE	DESCRIPTION	QTY	PER	PCK
757SS (PAIR)	PULL HANDLES (610MM) S/STEEL	1	EA	1



KOHI PULL HANDLE - BRUSHED STAINLESS STEEL

Architectural quality, tubular stainless steel 304.
 Suitable for timber, glass and aluminium doors
 Through door fixing. Fixings supplied. Door thickness 38 – 52mm.
 Roller latch set, use 729SS (supplied separately see page 32)
 Lock set use 716SSRLK60 (supplied separately see page 32)
 Size: 640mm (610mm C/C) 32mm tube

PRODUCT CODE	DESCRIPTION	QTY	PER	PCK
758SS (PAIR)	PULL HANDLES (640MM) S/STEEL	1	EA	1



DOOR HANDLES

ORAKEI PULL HANDLE - BRUSHED STAINLESS STEEL

Architectural quality, tubular stainless steel 304.
 Suitable for timber, glass and aluminium doors
 Through door fixing. Fixings supplied. Door thickness 40 – 52mm.
 Roller latch set, use 729SS (supplied separately see page 32)
 Lock set use 716SSRLK60 (supplied separately see page 32)
 Sizes: 600mm (570mm C/C) 32mm tube

PRODUCT CODE	DESCRIPTION	QTY	PER	PCK
759SS (PAIR)	PULL HANDLES (600MM) S/STEEL	1	EA	1



BOXTER PULL HANDLE - BRUSHED STAINLESS STEEL

Architectural quality, tubular stainless steel 304.
 Suitable for timber, glass and aluminium doors
 Through door fixing. Fixings supplied. Door thickness 40 – 52mm.
 Roller latch set, use 729SS (supplied separately see page 32)
 Lock set use 716SSSLK60 (supplied separately see page 32)
 Sizes: 600mm (580mm C/C) and 1000mm (980mm C/C)

PRODUCT CODE	DESCRIPTION	QTY	PER	PCK
760SS600 (PAIR)	PULL HANDLES (600MM) S/STEEL	1	EA	1
760SS1000 (PAIR)	PULL HANDLES (1000MM) S/STEEL	1	EA	1



NORWICH PULL HANDLE - BRUSHED STAINLESS STEEL

Architectural quality, solid stainless steel 304.
 Suitable for timber, glass and aluminium doors
 Through door fixing. Fixings supplied. Door thickness 40 – 52mm.
 Roller latch set, use 729SS (supplied separately see page 32)
 Lock set use 716SSSLK60 (supplied separately see page 32)
 Size: 600mm (425mm C/C)

PRODUCT CODE	DESCRIPTION	QTY	PER	PCK
762SS (PAIR)	PULL HANDLES (600MM) S/STEEL	1	EA	1



KENT PULL HANDLE - SOLID STAINLESS STEEL

Architectural quality, solid stainless steel 304.
 Suitable for timber, glass and aluminium doors
 Through door fixing. Fixings supplied. Door thickness 38 – 52mm.
 Roller latch set, use 729SS (supplied separately see page 32)
 Lock set use 716SSSLK60 (supplied separately see page 32)
 Size: 308mm (247mm C/C)

PRODUCT CODE	DESCRIPTION	QTY	PER	PCK
754SS (PAIR)	PULL HANDLES (310MM) S/STEEL	1	EA	1



DOOR HANDLES

EDEN PULL HANDLE - BRUSHED STAINLESS STEEL

Solid Cast.
 Suitable for Timber, Glass and Aluminium doors 40-52mm.
 Back to back fixing. Fixings supplied.
 Roses not included on back to back handles.
 Roses are included on single handles.
 250mm C/C. 52mm rose size. Door thickness 40 – 52mm.

PRODUCT CODE	DESCRIPTION	QTY	PER	PCK
767SS (PAIR)	PULL HANDLES S/STEEL	1	EA	1
764SS (SINGLE)	PULL HANDLE S/STEEL	1	EA	1



EPSOM PULL HANDLE - BRUSHED STAINLESS STEEL

Solid Cast.
 Suitable for Timber, Glass and Aluminium doors.
 Back to back fixing. Fixings supplied.
 Roses not included on back to back handles.
 Roses are included on single handles.
 Sizes: 250mm C/C. 52mm rose size. Door thickness 40 – 52mm.

PRODUCT CODE	DESCRIPTION	QTY	PER	PCK
768SS (PAIR)	PULL HANDLES S/STEEL	1	EA	1
765SS (SINGLE)	PULL HANDLE S/STEEL	1	EA	1



CURVO PULL HANDLE - BRUSHED STAINLESS STEEL

Solid Cast.
 Suitable for Timber, glass and Aluminium doors.
 Through door fixing. Fixings supplied.
 Door thickness 40 – 52mm.

Size: 210mm C/C

PRODUCT CODE	DESCRIPTION	QTY	PER	PCK
766SS (PAIR)	PULL HANDLES (210MM) S/STEEL	1	EA	1



SLIMLINE PULL HANDLE - BRUSHED STAINLESS STEEL

Offset handle design. Suitable for commercial applications
 19mm diameter solid Stainless Steel
 Suitable for timber, glass and aluminium doors
 Through door fixing. Fixings supplied. Door thickness 38 – 52mm.
 Roller latch set, use 729SS (supplied separately see page 32)
 Lock set use 716SSSLK60 (supplied separately see page 32)
 Sizes: 300mm centre to centre, 420mm overall
 600mm centre to centre, 840mm overall

PRODUCT CODE	DESCRIPTION	QTY	PER	PCK
9811908SS (PAIR)	SLIMLINE PULL HANDLE (300MM)	1	EA	1
9811909SS (PAIR)	SLIMLINE PULL HANDLE (600MM)	1	EA	1



DOOR HANDLES

SLIMLINE PULL HANDLE - BRUSHED STAINLESS STEEL

Straight handle design. Suitable for commercial applications
 19mm diameter solid Stainless Steel
 Suitable for timber, glass and aluminium doors
 Through door fixing. Fixings supplied. Door thickness 38 – 52mm.
 Roller latch set, use 729SS (supplied separately see page 32)
 Lock set use 716SSSLK60 (supplied separately see page 32)
 Sizes: 300mm centre to centre, 420mm overall
 600mm centre to centre, 840mm overall
 900mm centre to centre, 1260mm overall
 1200mm centre to centre, 1680mm overall

PRODUCT CODE	DESCRIPTION	QTY	PER	PCK
9811902SS (PAIR)	SLIMLINE PULL HANDLE (300MM)	1	EA	1
9811903SS (PAIR)	SLIMLINE PULL HANDLE (600MM)	1	EA	1
9811904SS (PAIR)	SLIMLINE PULL HANDLE (900MM)	1	EA	1
9811905SS (PAIR)	SLIMLINE PULL HANDLE (1200MM)	1	EA	1



OFFSET D HANDLE - BRUSHED STAINLESS STEEL

Offset handle design. Suitable for commercial applications
 32mm diameter tubular Stainless Steel
 Suitable for timber, glass and aluminium doors
 Through door fixing. Fixings supplied
 Roller latch set, use 729SS (supplied separately see page 32)
 Lock set use 716SSSLK60 (supplied separately see page 32)
 Size: 300mm centre to centre

PRODUCT CODE	DESCRIPTION	QTY	PER	PCK
98329SS (PAIR)	OFFSET D PULL HANDLE (300MM)	1	EA	1



D PULL HANDLE - BRUSHED STAINLESS STEEL

Offset handle design. Suitable for commercial applications
 32mm diameter tubular Stainless Steel
 Suitable for timber, glass and aluminium doors
 Through door fixing. Fixings supplied
 Roller latch set, use 729SS (supplied separately see page 32)
 Lock set use 716SSSLK60 (supplied separately see page 32)
 Size: 500mm centre to centre

PRODUCT CODE	DESCRIPTION	QTY	PER	PCK
98330SS (PAIR)	D PULL HANDLE 500MM	1	EA	1



HOW TO DETERMINE DOOR HANDING

Determining handing when ordering door hardware is different to how you determine door handing for carpentry (ordering and hanging doors). The reason being that when ordering hardware it matters which side the lock is on - where for carpentry it does not. If you follow the standard carpentry rules for handing, instead of following the diagram below, there is a good chance you may end up with a lock that is backwards. Please refer to the diagram below and if you have any questions, please give us a call.



Stand on the secure side of the door (where you would insert your key). For pairs, determine the hand of the active leaf. The active leaf is typically the door with the lockset. Both leaves may be active.

Follow These Steps:

- 1** Stand facing the door on the outside - If it's a locking door, stand on the side of the door where you would insert a key (or unlocking tool if it would be a privacy lock). For interior doors you would stand on the side of the door you enter from - i.e. in the hall if a hall closet, in the bedroom if a door opens to a bath, in the kitchen if a door opens to the pantry.
- 2** If the **hinges are on the left**, it's a **right hand door**. If the hinges are on the right, it's a left hand door.

DOOR HANDLES - COASTAL

KURA LEVER HANDLE - BRUSHED STAINLESS STEEL 304

Solid stainless steel handle. Suits door thickness 32mm-50mm.
 Concealed fixings supplied. Screw on cover plate.
 Latch set, use 415SS60 (supplied separately)
 Privacy set use 635SSBP (supplied separately)

PRODUCT CODE	DESCRIPTION	QTY	PER	PCK
690SS	KURA LEVER PASSAGE HANDLES	1	EA	5
690SSDL	KURA LEFT HAND DUMMY LEVER	1	EA	5
690SSDR	KURA RIGHT HAND DUMMY LEVER	1	EA	5



NILE LEVER HANDLE - BRUSHED STAINLESS STEEL 304

Solid stainless steel handle. Suits door thickness 32mm-50mm.
 Concealed fixings supplied. Screw on cover plate.
 Latch set, use 415SS60 (supplied separately)
 Privacy set use 635SSBP (supplied separately)

PRODUCT CODE	DESCRIPTION	QTY	PER	PCK
691SS	NILE LEVER PASSAGE HANDLES	1	EA	5
691SSDL	NILE LEFT HAND DUMMY LEVER	1	EA	5
691SSDR	NILE RIGHT HAND DUMMY LEVER	1	EA	5



LENA LEVER HANDLE - BRUSHED STAINLESS STEEL 304

Solid stainless steel handle. Suits door thickness 32mm-50mm.
 Concealed fixings supplied. Screw on cover plate.
 Latch set, use 415SS60 (supplied separately)
 Privacy set use 635SSBP (supplied separately)

PRODUCT CODE	DESCRIPTION	QTY	PER	PCK
692SS	LENA LEVER PASSAGE HANDLES	1	EA	5
692SSDL	LENA LEFT HAND DUMMY LEVER	1	EA	5
692SSDR	LENA RIGHT HAND DUMMY LEVER	1	EA	5



TIBER LEVER HANDLE - BRUSHED STAINLESS STEEL 304

Solid stainless steel handle. Suits door thickness 32mm-50mm.
 Concealed fixings supplied. Screw on cover plate.
 Latch set, use 415SS60 (supplied separately)
 Privacy set use 635SSBP (supplied separately)

PRODUCT CODE	DESCRIPTION	QTY	PER	PCK
693SS	TIBER LEVER PASSAGE HANDLES	1	EA	5
693SSDL	TIBER LEFT HAND DUMMY LEVER	1	EA	5
693SSDR	TIBER RIGHT HAND DUMMY LEVER	1	EA	5



DOOR HANDLES - COASTAL/SELIM

ISIS LEVER HANDLE - BRUSHED STAINLESS STEEL 304

Solid stainless steel handle. Suits door thickness 32mm-50mm.
 Concealed fixings supplied. Screw on cover plate.
 Latch set, use 415SS60 (supplied separately)
 Privacy set use 635SSBP (supplied separately)

PRODUCT CODE	DESCRIPTION	QTY	PER	PCK
695SS	ISIS LEVER PASSAGE HANDLES	1	EA	5
695SSDL	ISIS LEFT HAND DUMMY LEVER	1	EA	5
695SSDR	ISIS RIGHT HAND DUMMY LEVER	1	EA	5



MARIANA LEVER HANDLE - BRUSHED STAINLESS STEEL 304

Solid stainless steel handle. Suits door thickness 32mm-50mm.
 Concealed fixings supplied.
 Latch set, use 415SS60 (supplied separately)
 Privacy set use 635SSBP (supplied separately)

PRODUCT CODE	DESCRIPTION	QTY	PER	PCK
696SSL	MARIANA LEVER (LEFT HAND)	1	EA	5
696SSR	M ARIANA LEVER (RIGHT HAND)	1	EA	5
696SSDL	MARIANA L/HAND DUMMY LEVER	1	EA	5
696SSDR	MARIANA R/HAND DUMMY LEVER	1	EA	5



ARAL LEVER HANDLE - BRUSHED STAINLESS STEEL 304

Solid stainless steel handle. Suits door thickness 32mm-50mm.
 Concealed fixings supplied.
 Latch set, use 415SS60 (supplied separately)
 Privacy set use 635SSBP (supplied separately)

PRODUCT CODE	DESCRIPTION	QTY	PER	PCK
697SSL	ARAL LEVER (LEFT HAND)	1	EA	5
697SSR	ARAL LEVER (RIGHT HAND)	1	EA	5
697SSDL	ARAL LEFT HAND DUMMY LEVER	1	EA	5
697SSDR	ARAL RIGHT HAND DUMMY LEVER	1	EA	5



SELIM DOOR LATCH

Fixings supplied.
 Zinc diecast.
 Size: Plate 110mm.
 Spindle diameter 7.6mm

PRODUCT CODE	DESCRIPTION	QTY	PER	PCK
280CPLH	SELIM DOOR LATCH CHROME	1	EA	5
280SCLH	SELIM DOOR LATCH S/CHROME	1	EA	5



DOOR HANDLES - SELIM/PRO SERIES

SELIM DOOR SNIB

Fixings supplied.
Zinc diecast.
Size: Plate 110mm.
Spindle diameter 7.6mm

PRODUCT CODE	DESCRIPTION	QTY	PER	PCK
280CPS	SELIM DOOR SNIB CHROME	1	EA	5
280SCS	SELIM DOOR SNIB S/CHROME	1	EA	5



SELIM DOOR LOCK

Fixings supplied.
Zinc diecast.
Size: Plate 145mm.
Spindle diameter 7.6mm

PRODUCT CODE	DESCRIPTION	QTY	PER	PCK
280CPLK	SELIM DOOR LOCK CHROME	1	EA	5
280SCLK	SELIM DOOR LOCK S/CHROME	1	EA	5



CIRQUE ENTRANCE SET - BRUSHED STAINLESS STEEL

Concealed fixing. Fixings supplied.
Supplied with two latches, 60 or 70mm backset.
To fit 54mm hole.

Size: Base 65mm, Knob 50mm

PRODUCT CODE	DESCRIPTION	QTY	PER	PCK
870SS	CIRQUE ENTRANCE SET S/S	1	EA	6



CIRQUE PRIVACY SET - BRUSHED STAINLESS STEEL

Concealed fixing. Fixings supplied.
Ideal for bed and bathroom.
Supplied with two latches, 60 or 70mm backset.
To fit 54mm hole.

Size: Base 65mm, Knob 50mm.

PRODUCT CODE	DESCRIPTION	QTY	PER	PCK
871SS	CIRQUE PRIVACY SET S/S	1	EA	6



CIRQUE PASSAGE SET - BRUSHED STAINLESS STEEL

Concealed fixing. Fixings supplied.
Supplied with two latches, 60 or 70mm backset.
To fit 54mm hole.

Size: Base 65mm, Knob 50mm.

PRODUCT CODE	DESCRIPTION	QTY	PER	PCK
872SS	CIRQUE PASSAGE SET S/S	1	EA	6



DOOR HANDLES - PRO SERIES

CIRQUE DUMMY HANDLE - BRUSHED STAINLESS STEEL

Fixings supplied.

Size: Base 65mm, Knob 50mm.

PRODUCT CODE	DESCRIPTION	QTY	PER	PCK
873SS	CIRQUE DUMMY HANDLE S/S	1	EA	6



NEVA ENTRANCE SET

Concealed fixing. Fixings supplied.
 Supplied with 60/70mm backset adjustable tubular latch.
 To fit 54mm hole. Left and right handed options.
 Satin Nickel finish. Size: Base 65mm.

PRODUCT CODE	DESCRIPTION	QTY	PER	PCK
534SNL	NEVA L/HAND ENTRANCE SET	1	EA	6
534SNR	NEVA R/HAND ENTRANCE SET	1	EA	6



NEVA PRIVACY SET

Concealed fixing. Fixings supplied.
 Supplied with 60/70mm backset adjustable tubular latch.
 To fit 54mm hole. Left and right handed options.
 Satin Nickel finish. Size: Base 65mm.

PRODUCT CODE	DESCRIPTION	QTY	PER	PCK
531SNL	NEVA L/HAND PRIVACY SET	1	EA	6
531SNR	NEVA R/HAND PRIVACY SET	1	EA	6



NEVA PASSAGE SET

Concealed fixing. Fixings supplied.
 Supplied with 60/70mm backset adjustable tubular latch.
 To fit 54mm hole. Left and right handed options.
 Satin Nickel finish. Size: Base 65mm.

PRODUCT CODE	DESCRIPTION	QTY	PER	PCK
532SN	NEVA L/HAND PASSAGE SET	1	EA	6



NEVA DUMMY HANDLE

Concealed fixing. Fixings supplied.

Satin Nickel finish. Size: Base 65mm.

PRODUCT CODE	DESCRIPTION	QTY	PER	PCK
533SNL	NEVA L/HAND DUMMY HANDLE	1	EA	6
533SNR	NEVA R/HAND DUMMY HANDLE	1	EA	6



DOOR HANDLES - PRO SERIES

TURIN ENTRANCE SET

Concealed fixing. Fixings supplied.
 Supplied with 60/70mm backset adjustable tubular latch.
 To fit 54mm hole. Suits left and right hand applications.
 Size: Base 65mm.

PRODUCT CODE	DESCRIPTION	QTY	PER	PCK
878SN	TURIN ENTRANCE SET	1	EA	6



TURIN PRIVACY SET

Concealed fixing. Fixings supplied.
 Supplied with 60/70mm backset adjustable tubular latch.
 To fit 54mm hole. Suits left and right hand applications.
 Size: Base 65mm.

PRODUCT CODE	DESCRIPTION	QTY	PER	PCK
879SN	TURIN PRIVACY SET	1	EA	6



TURIN PASSAGE SET

Concealed fixing. Fixings supplied.
 Supplied with 60/70mm backset adjustable tubular latch.
 To fit 54mm hole. Suits left and right hand applications
 Satin Nickel finish. Size: Base 65mm.

PRODUCT CODE	DESCRIPTION	QTY	PER	PCK
880SN	TURIN PASSAGE SET	1	EA	6



TURIN DUMMY HANDLE

Concealed fixing. Fixings supplied.
 Left and right handed.
 Satin Nickel finish.
 Size: Base 65mm.

PRODUCT CODE	DESCRIPTION	QTY	PER	PCK
881SN	TURIN DUMMY HANDLE	1	EA	6



DOOR HANDLES - PRO SERIES

TRENTO ENTRANCE SET

Concealed fixing. Fixings supplied.
 Supplied with 60/70mm backset adjustable tubular latch.
 To fit 54mm hole. Left and right handed.
 Satin Nickel finish. Size: Base 65mm.

PRODUCT CODE	DESCRIPTION	QTY	PER	PCK
6101SN	TRENTO ENTRANCE SET	1	EA	6



TRENTO PRIVACY SET

Concealed fixing. Fixings supplied.
 Supplied with 60/70mm backset adjustable tubular latch.
 To fit 54mm hole. Suits left and right hand applications.
 Size: Base 65mm.

PRODUCT CODE	DESCRIPTION	QTY	PER	PCK
6102SN	TRENTO PRIVACY SET	1	EA	6



TRENTO PASSAGE SET

Concealed fixing. Fixings supplied.
 Supplied with 60/70mm backset adjustable tubular latch.
 To fit 54mm hole. Suits left and right hand applications
 Satin Nickel finish. Size: Base 65mm.

PRODUCT CODE	DESCRIPTION	QTY	PER	PCK
6103SN	TRENTO PASSAGE SET	1	EA	6



TRENTO DUMMY HANDLE

Concealed fixing. Fixings supplied.
 Left and right handed.
 Satin Nickel finish.
 Size: Base 65mm.

PRODUCT CODE	DESCRIPTION	QTY	PER	PCK
6104SN	TRENTO DUMMY HANDLE	1	EA	6



DOOR HANDLES - URBAN SERIES

URBAN SERIES WING LEVER HANDLES

Zinc Alloy construction. 55mm screw on rose to conceal included fixings.

Passage set requires: 9860SN latch.

Privacy set requires: 9860SN latch, 9801SS privacy bolt, 987009SN release & 987007SN privacy turn.

Entrance set requires: 716SS60 mortise lock, 717SN65KA5 cylinder & turn, & 2 x 987010SN escutcheons.

PRODUCT CODE	DESCRIPTION	QTY	PER	PCK
6401SN	WING PASSAGE SET	1	EA	1
6403LHSN	WING L/HAND DUMMY HANDLE	1	EA	1
6403RHSN	WING R/HAND DUMMY HANDLE	1	EA	1
6404SN	WING ENTRANCE COMBO SET	1	EA	1
6405SN	WING PRIVACY COMBO SET	1	EA	1



URBAN SERIES STRATOS LEVER HANDLES

Zinc Alloy construction. 55mm screw on rose to conceal included fixings.

Passage set requires: 9860SN latch.

Privacy set requires: 9860SN latch, 9801SS privacy bolt, 987009SN release & 987007SN privacy turn.

Entrance set requires: 716SS60 mortise lock, 717SN65KA5 cylinder & turn, & 2 x 987010SN escutcheons.

PRODUCT CODE	DESCRIPTION	QTY	PER	PCK
6501SN	STRATOS PASSAGE SET	1	EA	1
6503LHSN	STRATOS L/HAND DUMMY HANDLE	1	EA	1
6503RHSN	STRATOS R/HAND DUMMY HANDLE	1	EA	1
6504SN	STRATOS ENTRANCE COMBO SET	1	EA	1
6505SN	STRATOS PRIVACY COMBO SET	1	EA	1



URBAN SERIES BELLEVUE LEVER HANDLE

Solid casting Zinc Alloy handles. Square & round covers included.

To fit 19-22mm hole. Suits left and right hand applications.

Satin Nickel finish. Base sizes: 52mm diameter.

Passage set includes: Handles with interchangeable covers, 60mm latch with D shape striker plate and fixing screws.

Privacy set includes: Turn unit with interchangeable covers and 60mm bolt with fixing screws. (Privacy options pictured below handles)

Dummy handle includes: Single handle with interchangeable covers, taylor spindle and fixing screws.

Combo set includes: Passage handle set, 60mm latch with. D shape striker plate, fixings screws and Euro key lock unit (Round cover only)

PRODUCT CODE	DESCRIPTION	QTY	PER	PCK
6201SN	BELLEVUE PASSAGE SET	1	EA	6
6203SN	BELLEVUE DUMMY HANDLE ONLY	1	EA	6
6204SN	BELLEVUE ENTRANCE COMBO SET	1	EA	6
6205SN	BELLEVUE PRIVACY COMBO SET	1	EA	6



DOOR HANDLES - URBAN SERIES

URBAN SERIES TECOMO LEVER HANDLE

Solid casting Zinc Alloy handles. Square & round covers included.
To fit 19-22mm hole. Suits left and right hand applications.

Satin Nickel finish. Base sizes: 52mm diameter.

Passage set includes: Handles with interchangeable covers, 60mm latch with D shape striker plate and fixing screws.

Privacy set includes: Turn unit with interchangeable covers and 60mm bolt with fixing screws.

Dummy handle includes: Single handle with interchangeable covers, taylor spindle and fixing screws. . (Privacy options pictured below handles)

Combo set includes: Passage handle set, 60mm latch with D shape striker plate, fixings screws and Euro key lock unit (Round cover only).



PRODUCT CODE	DESCRIPTION	QTY	PER	PCK
6301SN	TECOMO PASSAGE SET	1	EA	6
6303SN	TECOMO DUMMY HANDLE ONLY	1	EA	6
6304SN	TECOMO ENTRANCE COMBO SET	1	EA	6
6305SN	TECOMO PRIVACY COMBO SET	1	EA	6

URBAN SERIES PRIVACY SET

Privacy set includes: Turn unit with interchangeable covers and 60mm bolt with fixing screws

PRODUCT CODE	DESCRIPTION	QTY	PER	PCK
6202SN	PRIVACY SET	1	EA	6



URBAN SERIES EURO KEY LOCK

Matching C4 keyed lock unit.
Concealed fixings

PRODUCT CODE	DESCRIPTION	QTY	PER	PCK
6205EULBOX	EURO KEY LOCK ROUND	1	EA	1
6206EULBOX	EURO KEY LOCK SQUARE	1	EA	1



DOOR STOPS

DOOR STOP - WALL MOUNT - ALUMINIUM

2 screw fixings supplied.
Base: 38mm, length: 75mm.

PRODUCT CODE	DESCRIPTION	QTY	PER	PCK
203BR	DOOR STOP ALUM. BRASS FINISH	1	EA	10
203CP	DOOR STOP ALUM. ANODISED	1	EA	10
203FB	DOOR STOP ALUM. BRONZE	1	EA	10
203PW	DOOR STOP ALUM. WHITE	1	EA	10
203SC	DOOR STOP ALUM. S/ANODISED	1	EA	10
203SCB	DOOR STOP BULK S/ANODISED	50	EA	1



DOOR STOP - WALL MOUNT - SOLID BRASS

3 screw fixings supplied.

Base: 45mm, length: 87mm.

PRODUCT CODE	DESCRIPTION	QTY	PER	PCK
204BR	DOOR STOP BRASS	1	EA	10
204SC	DOOR STOP SATIN CHROME	1	EA	10



DOOR STOP - WALL MOUNT - SOLID BRASS

Fixings supplied.
Concealed fixing.
Base: 28mm, length: 77mm

PRODUCT CODE	DESCRIPTION	QTY	PER	PCK
403BR	DOOR STOP BRASS	1	EA	10
403SC	DOOR STOP S/CHROME	1	EA	10
403SCB	DOOR STOP BULK S/CHROME	50	EA	1



DOOR STOP - WITH HOOK - STAINLESS STEEL

Door Stop and hook
Stainless steel
Concealed fixing. Fixings included.
Base: 50mm, length: 95mm

PRODUCT CODE	DESCRIPTION	QTY	PER	PCK
604SS	DOOR STOP WITH HOOK S/STEEL	1	EA	10



DOOR STOPS

DOOR STOP - WALL MOUNT - PLASTIC

Plastic cushion type door stop.
Concealed fixing. Fixings included
Base: 35mm, length: 75mm.

PRODUCT CODE	DESCRIPTION	QTY	PER	PCK
605PW	DOOR STOP PLASTIC	1	EA	20
605PW10	DOOR STOP 10 PACK PLASTIC	10	EA	1
605PWB	DOOR STOP BULK PLASTIC	50	EA	1

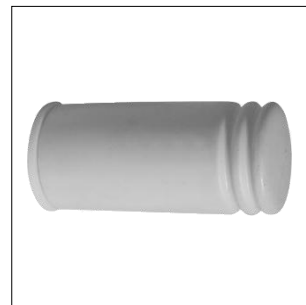

DOOR STOP - WALL MOUNT - ZINC DIECAST

Fixings supplied.
Grey tip.

Base: 37mm, length: 75mm.

PRODUCT CODE	DESCRIPTION	QTY	PER	PCK
701BR	DOOR STOP BRASS	1	EA	10
701SC	DOOR STOP S/CHROME	1	EA	10



DOOR STOP & HOOK - WALL MOUNT - ZINC DIECAST

Fixings supplied.
Black tip.

Base: 39mm, length: 90mm.

PRODUCT CODE	DESCRIPTION	QTY	PER	PCK
702SC	DOOR STOP W/HOOK S/CHROME	1	EA	6



DOOR STOP - WALL MOUNT - STAINLESS STEEL

Fixings supplied.
Concealed fixing.
Made from solid Stainless Steel 304.

Base: 32mm, length: 83mm.

PRODUCT CODE	DESCRIPTION	QTY	PER	PCK
400SS	DOOR STOP STAINLESS STEEL	1	EA	20



DOOR STOP - WALL MOUNT - ZINC DIECAST

Fixings supplied.
Concealed fixing.

Base: 32mm, length: 83mm.

PRODUCT CODE	DESCRIPTION	QTY	PER	PCK
404SN	DOOR STOP SATIN NICKEL FINISH	1	EA	10



DOOR STOPS

DOOR STOP - WALL MOUNT - ZINC DIECAST

Fixings supplied.
Concealed fixing.

Base: 32mm length: 80mm

PRODUCT CODE	DESCRIPTION	QTY	PER	PCK
400SC	DOOR STOP SATIN CHROME	1	EA	10



DOOR STOP - WALL MOUNT - ZINC DIECAST

Fixings supplied.
Concealed fixing.
Two sizes available.
Base: 32mm, lengths: 85mm & 105mm

PRODUCT CODE	DESCRIPTION	QTY	PER	PCK
202DS85A	DOOR STOP (85MM) S/CHROME	1	EA	10
202DS105A	DOOR STOP (105MM) S/CHROME	1	EA	10



SQUARE DOOR STOP - WALL MOUNT - ZINC DIECAST

Fixings supplied.
Zinc diecast.
Base: 40mm, lengths: 80mm & 100mm

PRODUCT CODE	DESCRIPTION	QTY	PER	PCK
231SC	DOOR STOP (80MM) S/CHROME	1	EA	10
231SC100	DOOR STOP (100MM) S/CHROME	1	EA	10



SQUARE DOOR STOP - WALL MOUNT - ZINC DIECAST

Fixings supplied.
Concealed fixing.
Base: 25mm, lengths: 80mm & 100mm

PRODUCT CODE	DESCRIPTION	QTY	PER	PCK
232SC	DOOR STOP (80MM) S/CHROME	1	EA	10
232SC100	DOOR STOP (100MM) S/CHROME	1	EA	10



DOOR STOP - WALL MOUNT - STAINLESS STEEL

Fixings supplied.
Concealed fixing.
Made from Stainless Steel 304.

Base: 25mm, length: 70mm

PRODUCT CODE	DESCRIPTION	QTY	PER	PCK
601SS	DOOR STOP STAINLESS STEEL	1	EA	10



DOOR STOPS

DOOR STOP - FLOOR MOUNT - ALUMINIUM

Supplied with M8 hanger bolt fixing & 8mm dynabolt.
 Suitable for concrete & timber floors.
 Two sizes: Base: 37mm, 52mm diameter, length 38mm & 60mm.
 Height 60mm available in Satin finish only.

PRODUCT CODE	DESCRIPTION	QTY	PER	PCK
207BR	DOOR STOP BRASS FINISH	1	EA	10
207FB	DOOR STOP BRONZE	1	EA	10
207SC	DOOR STOP S/ANODISED	1	EA	10
207BS60	DOOR STOP (60MM) S/ANODISED	1	EA	10
207SCB	DOOR STOP BULK S/ANODISED	50	EA	1



DOOR STOP - TWO PIECE FLOOR MOUNT - ALUMINIUM

Supplied with M8 hanger bolt fixing & 8mm dynabolt.
 Suitable for concrete & timber floors.

Base 37mm, 52mm diameter, length 38mm

PRODUCT CODE	DESCRIPTION	QTY	PER	PCK
207SC2	2 PIECE DOOR STOP S/CHROME	1	EA	10
207SC2B	2 PIECE DOOR STOP BULK S/CHR.	50	EA	1



DOOR STOP - FLOOR MOUNT - ZINC DIECAST

Fixings supplied.
 Concealed fixing.

Base: 40mm, length: 32mm

PRODUCT CODE	DESCRIPTION	QTY	PER	PCK
723BR	DOOR STOP BRASS FINISH	1	EA	10
723SC	DOOR STOP BRUSHED S/CHROME	1	EA	10



SQUARE DOOR STOP - FLOOR MOUNT - STAINLESS STEEL

Fixings supplied.
 Concealed fixing.
 Made from Stainless Steel 304.
 Base: 46mm, length: 27mm

PRODUCT CODE	DESCRIPTION	QTY	PER	PCK
724SS	DOOR STOP STAINLESS STEEL	1	EA	10



DOOR STOPS

DOOR STOP - FLOOR MOUNT - STAINLESS STEEL

Fixings supplied.
Concealed fixing.
Made from Stainless Steel 304.

Base: 42mm, length: 40mm

PRODUCT CODE	DESCRIPTION	QTY	PER	PCK
726SS	DOOR STOP STAINLESS STEEL	1	EA	10



DOOR STOP - FLOOR MOUNT - STAINLESS STEEL

Supplied with M8 hanger bolt fixing.
Suitable for concrete & timber floors.
Supplied with a dynabolt 8mm thread.
Base: 28mm, length: 40mm
Base: 28mm, length: 65mm

PRODUCT CODE	DESCRIPTION	QTY	PER	PCK
201FS40SS	DOOR STOP 40MM STAINLESS	1	EA	10
201FS65SS	DOOR STOP 65 MM STAINLESS	1	EA	10



DOOR STOP - FLOOR MOUNT - ZINC DIECAST

Fixings supplied.
Concealed fixing.

Base: 46mm, height: 27mm

PRODUCT CODE	DESCRIPTION	QTY	PER	PCK
98725SC	DOOR STOP S/CHROME	1	EA	10



DOOR STOP - FLOOR MOUNT - ZINC DIECAST

Fixings supplied.
Concealed fixing.

Base width: 46mm, height: 27mm

PRODUCT CODE	DESCRIPTION	QTY	PER	PCK
206SC	DOOR STOP SATIN CHROME	1	EA	10

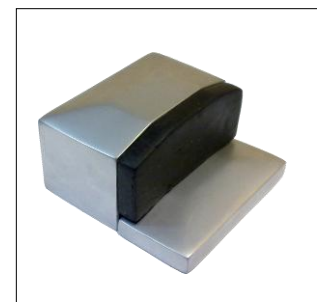

FLOOR MOUNT DOOR STOP & HOLDER - ZINC DIECAST

Fixings supplied.

Size: Height 45mm. Base 44mm x 28mm.
Holder 44mm x 28mm.

PRODUCT CODE	DESCRIPTION	QTY	PER	PCK
212SCF	DOOR STOP & HOLDER S/CHROME	1	EA	10



DOOR STOPS

SQUARE DOOR STOP WITH BASE - FLOOR MOUNT

Fixings supplied.
Aluminium door stop with a Zinc base.

Base: 40mm, length 44mm.

PRODUCT CODE	DESCRIPTION	QTY	PER	PCK
220SC	DOOR STOP W/BASE S/CHROME	1	EA	10



DOOR STOP - FLOOR MOUNT - ALUMINIUM

Fixings supplied.
Concealed fixing.

Base: 25mm, length 40mm.

PRODUCT CODE	DESCRIPTION	QTY	PER	PCK
221SC	DOOR STOP S/ANODISED	1	EA	10



DOOR STOP - LATCHING WALL MOUNT - ZINC DIECAST

Powder coat finishes available, suitable for exterior use.
Satin Black and MN White in stock. Base: 45mm, length: 80mm
Other Colours available on request. Minimum order required

PRODUCT CODE	DESCRIPTION	QTY	PER	PCK
600SC	LATCH. DOOR STOP P/COAT SATIN	1	EA	10
600PB	LATCH. DOOR STOP P/COAT BLACK	1	EA	10
600PW	LATCH. DOOR STOP P/COAT WHITE	1	EA	10
600RM	LATCH. DOOR STOP RAW FINISH	1	EA	10



DOOR STOP – SELF LATCHING WALL MOUNT - ZINC DIECAST

Designed by Miles Nelson.

Powder coat zinc alloy.
Suitable for interior and exterior use. Fits both a left and right sided door.
Foot operated release. Fixings supplied.
Base: 50mm, length: 80mm

PRODUCT CODE	DESCRIPTION	QTY	PER	PCK
700SC	LATCHING DOOR STOP SATIN	1	EA	4



FLOOR MOUNT DOOR STOP & HOLDER - ZINC DIECAST

3 screw fixing on base and holder.
Screw fixings supplied.

Base: 40mm, length: 75mm
Holder 44mm x 28mm.

PRODUCT CODE	DESCRIPTION	QTY	PER	PCK
703BR	STOP & HOLDER BRASS FINISH	1	EA	8
703SC	DOOR STOP & HOLDER S/CHROME	1	EA	8



DOOR STOPS

DOOR STOP - LATCHING WALL MOUNT - ZINC DIECAST

Square base with 4 screw fixings.
Swivelling latch.

PRODUCT CODE	DESCRIPTION	QTY	PER	PCK
218SC	L/BACK DOOR STOP S/CHROME	1	EA	10
218SN	L/BACK DOOR STOP S/NICKEL	1	EA	10



HEAVY DUTY LATCH BACK DOOR STOP - FORGED BRASS

Stainless Steel screw fixings supplied.
Suitable for exterior use

Size: Upstand: 45mm x 68mm base, 105mm engaged height.
Eyelet: 39mm wide, 62mm long.

PRODUCT CODE	DESCRIPTION	QTY	PER	PCK
608SC	HD DOOR STOP S/CHROME	1	EA	10



LATCH BACK - WALL MOUNT - SOLID BRASS

Fixings supplied.
Suitable for exterior use

Size: Base 61 x 38mm. Hook 60mm.
Engaged length: 105mm overall.

PRODUCT CODE	DESCRIPTION	QTY	PER	PCK
277SC	LATCH BACK D/STOP S/CHROME	1	EA	5

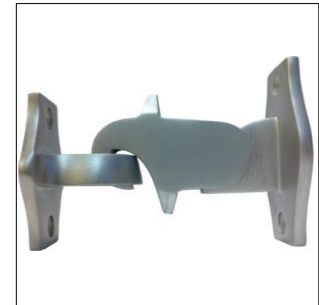

MAGNETIC WALL/FLOOR MOUNT DOOR STOP - ZINC

Magnetic door stop
Concealed fixing. Fixings included & dynabolt for concrete fixing.
Base: 45mm, Length: 80mm

PRODUCT CODE	DESCRIPTION	QTY	PER	PCK
603SC	MAGNETIC DOOR STOP S/CHROME	1	EA	10



MAGNETIC HOLDER – FLOOR MOUNT - ZINC

Fixings supplied.
Cushion sprung magnet.

Width: 45mm, Height: 39mm

PRODUCT CODE	DESCRIPTION	QTY	PER	PCK
704BR	MAG. DOOR HOLDER BRASS	1	EA	10
704SC	MAG. DOOR HOLDER S/CHROME	1	EA	10



DOOR STOPS

MAGNETIC HOLDER – FLOOR /WALL MOUNT - SOLID BRASS

Fixings supplied.
Spring cushioned catch.

Base: 50mm, Length: 75mm Holder: 31mm diameter.

PRODUCT CODE	DESCRIPTION	QTY	PER	PCK
705BR	MAG. DOOR HOLDER BRASS	1	EA	6
705SC	MAG. DOOR HOLDER S/CHROME	1	EA	6



MAG. DOOR STOP - FLOOR/WALL MOUNT - ZINC DIECAST

Fixings supplied.
Concealed fixing.
Spring cushioned magnetic catch.

Base: 40mm length: 78mm.

PRODUCT CODE	DESCRIPTION	QTY	PER	PCK
714SN	MAGNETIC DOOR STOP S/NICKEL	1	EA	10



WALL MOUNT – SPRING STEEL

Fixings supplied.
Concealed fixing.
White rubber tip.

Base: 25mm length: 80mm.

PRODUCT CODE	DESCRIPTION	QTY	PER	PCK
606CP	SPRING DOOR STOP CHROME	1	EA	20



SQUARE DOOR STOPWALL MOUNT – STAINLESS STEEL

Screw fixing built in to base.
Black rubber tip.
Brushed stainless steel.

Shaft width 16mm, Length: 80mm

PRODUCT CODE	DESCRIPTION	QTY	PER	PCK
402SS	DOOR STOP STAINLESS STEEL	1	EA	10



HINGES

STAINLESS STEEL HINGE – SMALL

304 or 316 grade Stainless Steel.
Satin finish.
Fixed pin, square edge, ball bearing hinge.
Size: 75mm x 50mm x 2mm.

PRODUCT CODE	DESCRIPTION	QTY	PER	PCK
520SSH7550304S	HINGE 75X50X2 304G S/STEEL	1	EA	20
520SSH7550316S	HINGE 75X50X2 316G S/STEEL	1	EA	20



STAINLESS STEEL HINGE – LARGE

304 grade Stainless Steel.
Satin finish.
Fixed pin, square edge, ball bearing hinge.
Size: 100mm x 75mm x 2.5mm.

PRODUCT CODE	DESCRIPTION	QTY	PER	PCK
520SSH10075304S	HINGE 100X75X2.5 S/STEEL	1	EA	20



STAINLESS STEEL HINGE – RADIUS EDGES

304 grade Stainless Steel.
Satin Finish.
Fixed pin, radius edge, ball bearing hinge.
Size: 100mm x 75mm x 2.5mm.

PRODUCT CODE	DESCRIPTION	QTY	PER	PCK
520SSH10075R	HINGE 100X75X2.5 S/STEEL	1	EA	20



SATIN NICKEL HINGE – RADIUS EDGES

Brushed satin finish.
Loose Pin.
Radius edge.
Size: 90mm x 60mm x 2mm.

PRODUCT CODE	DESCRIPTION	QTY	PER	PCK
520SNH9060	HINGE 90X60X2 SATIN NICKEL	1	EA	20



HINGES

STAINLESS STEEL HINGE – BUTT HINGE

304 grade Stainless Steel.
 Satin Finish.
 Fixed pin, square edge, ball bearing hinge.
 Size: 100mm x 100mm x 2mm.

PRODUCT CODE	DESCRIPTION	QTY	PER	PCK
520SSH100100	HINGE 100X100X2 304G S/STEEL	1	EA	20

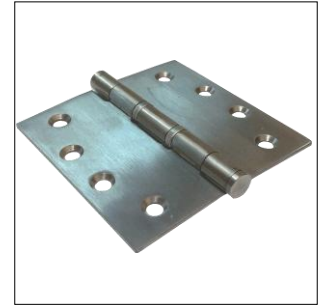

STAINLESS STEEL FAST FIX FLUSH BALL BEARING HINGE

304 grade Stainless Steel.
 Satin Finish.
 Fixed pin, square edge, ball bearing hinge.
 Size: 100mm x 71mm x 2.5mm.

PRODUCT CODE	DESCRIPTION	QTY	PER	PCK
981071FFBS	HINGE 100X71X2.5 S/STEEL	1	EA	20



HOOKS

HAT & COAT HOOK - ZINC DIECAST

Fixings supplied.

PRODUCT CODE	DESCRIPTION	QTY	PER	PCK
102FB	HAT & COAT HOOK BRONZE	1	EA	20
102CP	HAT & COAT HOOK CHROME	1	EA	20
102SC	HAT & COAT HOOK S/CHROME	1	EA	20
102PW	HAT & COAT HOOK WHITE	1	EA	20
102GD	HAT & COAT HOOK GOLD	1	EA	20



WARDROBE HOOK - ZINC DIECAST

Fixings supplied.

PRODUCT CODE	DESCRIPTION	QTY	PER	PCK
103FB	HAT & COAT HOOK BRONZE	1	EA	20
103CP	HAT & COAT HOOK CHROME	1	EA	20
103SC	HAT & COAT HOOK S/CHROME	1	EA	20
103PW	HAT & COAT HOOK WHITE	1	EA	20
103GD	HAT & COAT HOOK GOLD	1	EA	20



HAT & COAT HOOK - ALUMINIUM

Fixings supplied.

PRODUCT CODE	DESCRIPTION	QTY	PER	PCK
273FB	HAT & COAT HOOK BRONZE	1	EA	10
273CP	HAT & COAT HOOK B/ANODISED	1	EA	10
273SC	HAT & COAT HOOK S/ANODISED	1	EA	10
273SCB	HAT & COAT HOOK S/ANODISED	50	EA	1



WARDROBE HOOKS - ALUMINIUM

Fixings supplied.

PRODUCT CODE	DESCRIPTION	QTY	PER	PCK
274FB	WARDROBE HOOK BRONZE	1	EA	10
274CP	WARDROBE HOOK B/ANODISED	1	EA	10
274SC	WARDROBE HOOK S/ANODISED	1	EA	10



FIN DESIGNER HOOKS - ZINC DIECAST

Fixings supplied. Concealed fixings.

PRODUCT CODE	DESCRIPTION	QTY	PER	PCK
735CP	FIN HOOK CHROME	1	EA	10
735SC	FIN HOOK S/CHROME	1	EA	10



KICK PLATES, PUSH PLATES & GRAB RAILS

KICK PLATES 200MM WIDE - STAINLESS STEEL

Fixings supplied, pre drilled & countersunk holes. Brushed 304 Stainless Steel.

PRODUCT CODE	DESCRIPTION	QTY	DOOR SIZE
500KP610-200	KICK PLATE 585 X 200 X 1.2 (MM)	1	610
500KP710-200	KICK PLATE 685 X 200 X 1.2 (MM)	1	710
500KP760-200	KICK PLATE 735 X 200 X 1.2 (MM)	1	760
500KP810-200	KICK PLATE 785 X 200 X 1.2 (MM)	1	810
500KP860-200	KICK PLATE 835 X 200 X 1.2 (MM)	1	860
500KP910-200	KICK PLATE 885 X 200 X 1.2 (MM)	1	910
500KP1200-200	KICK PLATE 1200 X 200 X 1.2 (MM)	1	1200



KICK PLATES 300MM WIDE - STAINLESS STEEL

Fixings supplied, pre drilled & countersunk holes. Brushed 304 Stainless Steel.

PRODUCT CODE	DESCRIPTION	QTY	DOOR SIZE
501KP610-300	KICK PLATE 585 X 300 X 1.2 (MM)	1	610
501KP710-300	KICK PLATE 685 X 300 X 1.2 (MM)	1	710
501KP760-300	KICK PLATE 735 X 300 X 1.2 (MM)	1	760
501KP810-300	KICK PLATE 785 X 300 X 1.2 (MM)	1	810
501KP860-300	KICK PLATE 835 X 300 X 1.2 (MM)	1	860
501KP910-300	KICK PLATE 885 X 300 X 1.2 (MM)	1	910
501KP1200-300	KICK PLATE 1200 X 300 X 1.2 (MM)	1	1200



RESTROOM SIGN MEN/WOMEN – STAINLESS STEEL

Fixings supplied.
75mm diameter.
Made from brushed 304 Stainless Steel.

PRODUCT CODE	DESCRIPTION	QTY	PER	PCK
503PPTM	RESTROOM SIGN MEN S/STEEL	1	EA	20
503PPTW	RESTROOM SIGN WOMEN S/STEEL	1	EA	20



RESTROOM SIGN UNISEX/DISABLED – STAINLESS STEEL

Fixings supplied.
75mm diameter.
Made from brushed 304 Stainless Steel.

PRODUCT CODE	DESCRIPTION	QTY	PER	PCK
503PPTM/W	RESTROOM SIGN UNISEX S/STEEL	1	EA	20
503PPTDIS	RESTROOM SIGN DIS. S/STEEL	1	EA	20



KICK PLATES, PUSH PLATES & GRAB RAILS

RESTROOM SIGN PUSH/PULL – STAINLESS STEEL

Fixings supplied.
75mm diameter.
Made from brushed 304 Stainless Steel.

PRODUCT CODE	DESCRIPTION	QTY	PER	PCK
503PUSPR	RESTROOM SIGN PUSH S/STEEL	1	EA	20
503PULPR	RESTROOM SIGN PULL S/STEEL	1	EA	20

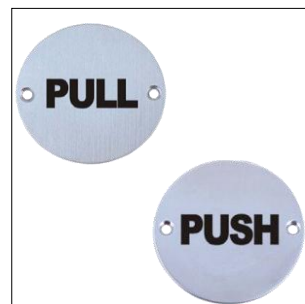

PULL PLATE/PUSH PLATE - STAINLESS STEEL

Fixings supplied. Made from brushed 304 Stainless Steel.
Push plate available engraved or blank.
Size: Height 300mm, Width 100mm.

PRODUCT CODE	DESCRIPTION	QTY	PER	PCK
502PPENGRH	PULL PLATE W/HANDLE S/STEEL	1	EA	2
502PPENGR	PUSH PLATE S/STEEL	1	EA	10
502PP300-100	PUSH PLATE (BLANK) S/STEEL	1	EA	10



D PULL HANDLES - STAINLESS STEEL

Fixings supplied. 15mm diameter brushed tubular stainless steel handle.
Suitable for commercial applications
Handle sizes: 200mm, 250mm and 300mm centre to centre. Overall sizes below.

PRODUCT CODE	DESCRIPTION	QTY	PER	PCK
9810200SS	D PULL HANDLE 250MM X 60MM	1	EA	1
9810250SS	D PULL HANDLE 300MM X 60MM	1	EA	1
9810300SS	D PULL HANDLE 350MM X 60MM	1	EA	1



STRAIGHT HANDLE GRAB RAIL - 304 STAINLESS STEEL

Heavy Duty 25mm diameter tube.
Knurled grip.
Concealed screw fixings.

PRODUCT CODE	DESCRIPTION	QTY	PER	PCK
530GR300SS	GRAB RAIL (300MM) S/STEEL	1	EA	5
530GR400SS	GRAB RAIL (400MM) S/STEEL	1	EA	5
530GR600SS	GRAB RAIL (600MM) S/STEEL	1	EA	5



CURVED HANDLE GRAB RAIL - 304 STAINLESS STEEL

Heavy Duty 25mm diameter tube.
Knurled grip.
Concealed screw fixing's
45 degree curve (150mm centre to end).

PRODUCT CODE	DESCRIPTION	QTY	PER	PCK
535GRB150SS	CURVED GRAB RAIL S/STEEL	1	EA	5



LETTERBOX LETTERS & NUMBERS

LETTERS A TO E – BRUSHED 304 STAINLESS STEEL

Concealed fixings supplied. Size: 100mm

PRODUCT CODE	DESCRIPTION	QTY	PER	PCK
722SS100A	ALPHABET LETTER (A) S/STEEL	1	EA	10
722SS100B	ALPHABET LETTER (B) S/STEEL	1	EA	10
722SS100C	ALPHABET LETTER (C) S/STEEL	1	EA	10
722SS100D	ALPHABET LETTER (D) S/STEEL	1	EA	10
722SS100E	ALPHABET LETTER (E) S/STEEL	1	EA	10

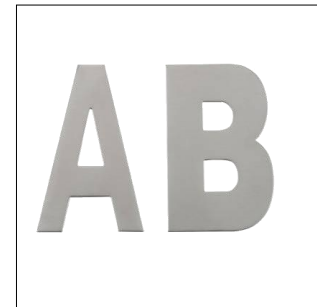

NUMBERS 0 TO 9 - BRUSHED 304 STAINLESS STEEL

Concealed fixings supplied. Size: 100mm

PRODUCT CODE	DESCRIPTION	QTY	PER	PCK
721SS1000	NUMBER PLATE (0) S/STEEL	1	EA	10
721SS1001	NUMBER PLATE (1) S/STEEL	1	EA	10
721SS1002	NUMBER PLATE (2) S/STEEL	1	EA	10
721SS1003	NUMBER PLATE (3) S/STEEL	1	EA	10
721SS1004	NUMBER PLATE (4) S/STEEL	1	EA	10
721SS1005	NUMBER PLATE (5) S/STEEL	1	EA	10
721SS1006	NUMBER PLATE (6) S/STEEL	1	EA	10
721SS1007	NUMBER PLATE (7) S/STEEL	1	EA	10
721SS1008	NUMBER PLATE (8) S/STEEL	1	EA	10
721SS1009	NUMBER PLATE (9) S/STEEL	1	EA	10

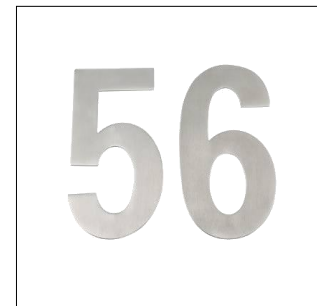

NUMBERS 0 TO 9 - BRUSHED 304 STAINLESS STEEL

Concealed fixings supplied. Size: 155mm

PRODUCT CODE	DESCRIPTION	QTY	PER	PCK
721SS1550	NUMBER PLATE (0) S/STEEL	1	EA	10
721SS1551	NUMBER PLATE (1) S/STEEL	1	EA	10
721SS1552	NUMBER PLATE (2) S/STEEL	1	EA	10
721SS1553	NUMBER PLATE (3) S/STEEL	1	EA	10
721SS1554	NUMBER PLATE (4) S/STEEL	1	EA	10
721SS1555	NUMBER PLATE (5) S/STEEL	1	EA	10
721SS1556	NUMBER PLATE (6) S/STEEL	1	EA	10
721SS1557	NUMBER PLATE (7) S/STEEL	1	EA	10
721SS1558	NUMBER PLATE (8) S/STEEL	1	EA	10
721SS1559	NUMBER PLATE (9) S/STEEL	1	EA	10



NECK BOLTS

NECK BOLTS - SOLID BRASS

Fixings supplied. 60mm length.
8mm forged Brass rod. Made from seamless brass extrusion.

PRODUCT CODE	DESCRIPTION	QTY	PER	PCK
269FB0860BP	NECK BOLT (60MM) BRONZE	1	EA	10
269CP0860BP	NECK BOLT (60MM) CHROME	1	EA	10
269BR0860BP	NECK BOLT (60MM) BRASS	1	EA	10
269SC0860BP	NECK BOLT (60MM) S/CHROME	1	EA	10

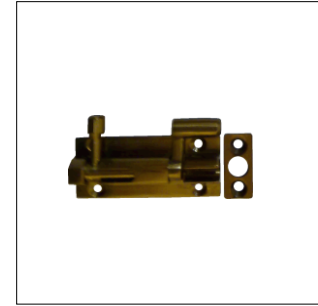

NECK BOLTS - SOLID BRASS

Fixings supplied. 75mm length.
8mm forged Brass rod. Made from seamless brass extrusion.

PRODUCT CODE	DESCRIPTION	QTY	PER	PCK
269FB0875BP	NECK BOLT (75MM) BRONZE	1	EA	10
269CP0875BP	NECK BOLT (75MM) CHROME	1	EA	10
269BR0875BP	NECK BOLT (75MM) BRASS	1	EA	10
269SC0875BP	NECK BOLT (75MM) S/CHROME	1	EA	10

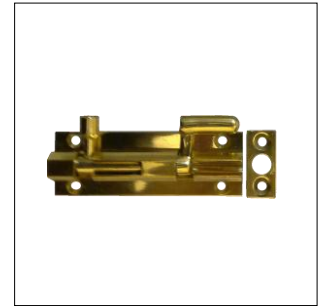

NECK BOLTS - SOLID BRASS

Fixings supplied. 100mm length.
8mm forged Brass rod. Made from seamless brass extrusion.

PRODUCT CODE	DESCRIPTION	QTY	PER	PCK
269FB08100BP	NECK BOLT (100MM) BRONZE	1	EA	10
269CP08100BP	NECK BOLT (100MM) CHROME	1	EA	10
269BR08100BP	NECK BOLT (100MM) BRASS	1	EA	10
269SC08100BP	NECK BOLT (100MM) S/CHROME	1	EA	10

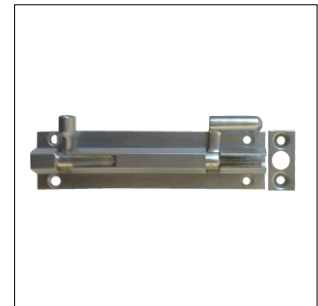

NECK BOLTS - SOLID BRASS

Fixings supplied. 150mm length.
10mm forged Brass rod. Made from seamless brass extrusion.

PRODUCT CODE	DESCRIPTION	QTY	PER	PCK
269FB10150	NECK BOLT (150MM) BRONZE	1	EA	10
269CP10150	NECK BOLT (150MM) CHROME	1	EA	10
269BR10150	NECK BOLT (150MM) BRASS	1	EA	10
269SC10150	NECK BOLT (150MM) S/CHROME	1	EA	10

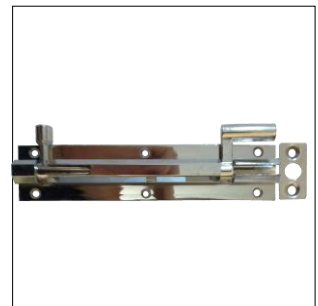

NECK BOLTS - BRASS

Fixings supplied. 60mm length.
8mm Brass rod. Made with an open seam body.

PRODUCT CODE	DESCRIPTION	QTY	PER	PCK
469FB0860	NECK BOLT (60MM) BRONZE	1	EA	20
469CP0860	NECK BOLT (60MM) CHROME	1	EA	20
469BR0860	NECK BOLT (60MM) BRASS	1	EA	20
469SC0860	NECK BOLT (60MM) S/CHROME	1	EA	20

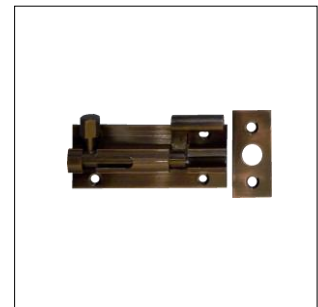

NECK BOLTS

NECK BOLTS - BRASS

Fixings supplied. 75mm length.
8mm Brass rod. Made with an open seam body.

PRODUCT CODE	DESCRIPTION	QTY	PER	PCK
469FB0875	NECK BOLT (75MM) BRONZE	1	EA	20
469CP0875	NECK BOLT (75MM) CHROME	1	EA	20
469BR0875	NECK BOLT (75MM) BRASS	1	EA	20
469SC0875	NECK BOLT (75MM) S/CHROME	1	EA	20

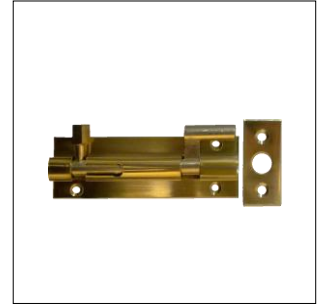

NECK BOLTS - BRASS

Fixings supplied. 100mm length.
8mm Brass rod. Made with an open seam body.

PRODUCT CODE	DESCRIPTION	QTY	PER	PCK
469FB08100	NECK BOLT (100MM) BRONZE	1	EA	20
469CP08100	NECK BOLT (100MM) CHROME	1	EA	20
469BR08100	NECK BOLT (100MM) BRASS	1	EA	20
469SC08100	NECK BOLT (100MM) S/CHROME	1	EA	20

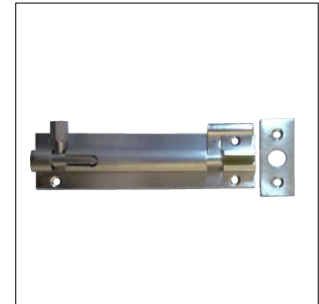

NECK BOLTS - BRASS

Fixings supplied. 150mm length.
10mm Brass rod. Made with an open seam body.

PRODUCT CODE	DESCRIPTION	QTY	PER	PCK
469FB10150	NECK BOLT (150MM) BRONZE	1	EA	20
469CP10150	NECK BOLT (150MM) CHROME	1	EA	20
469BR10150	NECK BOLT (150MM) BRASS	1	EA	20
469SC10150	NECK BOLT (150MM) S/CHROME	1	EA	20



FLAT PLATE ONLY - BRASS

Suits 8mm neck bolts & socket bolts.

PRODUCT CODE	DESCRIPTION	QTY	PER	PCK
272FB08	FLAT PLATE (8MM) BRONZE	1	EA	20
272CP08	FLAT PLATE (8MM) CHROME	1	EA	20
272BR08	FLAT PLATE (8MM) BRASS	1	EA	20
272SC08	FLAT PLATE (8MM) S/CHROME	1	EA	20



FLAT PLATE ONLY - BRASS

Suits 10mm neck bolts & socket bolts.

PRODUCT CODE	DESCRIPTION	QTY	PER	PCK
272FB10	FLAT PLATE (10MM) BRONZE	1	EA	10
272CP10	FLAT PLATE (10MM) CHROME	1	EA	10
272BR10	FLAT PLATE (10MM) BRASS	1	EA	10
272SC10	FLAT PLATE (10MM) S/CHROME	1	EA	10



SECURITY FITTINGS

WINDOW STAYS - FOR ALUMINIUM

Designed by Miles Nelson. Unique glide and positioning design ensures easy window operation. Can be detached for full window opening.
Easy DIY installation. Suitable for left and right handed installation.
Recommended to install two per window.

PRODUCT CODE	DESCRIPTION	QTY	PER	PCK
250PWA1	WINDOW STAY (1 PACK) WHITE	1	EA	20
250SCA1	WINDOW STAY (1 PACK) SATIN	1	EA	20
250PBA1	WINDOW STAY (1 PACK) BLACK	1	EA	20
250PBA2	WINDOW STAY (2 PACK) BLACK	1	EA	20
250PWA2	WINDOW STAY (2 PACK) WHITE	1	EA	20
250PWA4	WINDOW STAY (4 PACK) WHITE	1	EA	10
250SCA4	WINDOW STAY (4 PACK) SATIN	1	EA	10
250PBA4	WINDOW STAY (4 PACK) BLACK	1	EA	10



WINDOW STAYS - FOR TIMBER

Designed by Miles Nelson. Unique glide and positioning design ensures easy window operation. Can be detached for full window opening.
Easy DIY installation. Suitable for left and right handed installation.
Recommended to install two per window.

PRODUCT CODE	DESCRIPTION	QTY	PER	PCK
250PWT1	WINDOW STAY (1 PACK) WHITE	1	EA	20
250SCT1	WINDOW STAY (1 PACK) SATIN	1	EA	20
250PWT2	WINDOW STAY (2 PACK) WHITE	1	EA	20
250PWT4	WINDOW STAY (4 PACK) WHITE	1	EA	10
250SCT4	WINDOW STAY (4 PACK) SATIN	1	EA	10



PATIO BOLTS

Designed by Miles Nelson. Secure locking function & new slim design.
Easy DIY installation. High level security with concealed screws.
Throw size: 45mm.

PRODUCT CODE	DESCRIPTION	QTY	PER	PCK
281PW1	PATIO BOLT (1 PACK) WHITE	1	EA	10
281SC1	PATIO BOLT (1 PACK) S/CHROME	1	EA	10
281PB1	PATIO BOLT (1 PACK) BLACK	1	EA	10
281PW2	PATIO BOLT (2 PACK) WHITE	1	EA	10
281SC2	PATIO BOLT (2 PACK) S/CHROME	1	EA	10
281PB2	PATIO BOLT (2 PACK) BLACK	1	EA	10



SECURITY FITTINGS

MINI BOLTS

Designed by Miles Nelson. Secure locking function & new slim design. Easy DIY installation. High level security with concealed screws. Throw size: 28mm.

PRODUCT CODE	DESCRIPTION	QTY	PER	PCK
282PW1	MINI BOLT (1 PACK) WHITE	1	EA	10
282SC1	MINI BOLT (1 PACK) S/CHROME	1	EA	10
282PB1	MINI BOLT (1 PACK) BLACK	1	EA	10
282PW2	MINI BOLT (2 PACK) WHITE	1	EA	10
282SC2	MINI BOLT (2 PACK) S/CHROME	1	EA	10
282PB2	MINI BOLT (2 PACK) BLACK	1	EA	10



DOOR LOCK

Ideal for replacement, the larger lock body covers most installations marks. Optional dead locking from outside. High specification cylinder for greater security. Supplied with three keys. Fixings supplied easy installation.

PRODUCT CODE	DESCRIPTION	QTY	PER	PCK
716CP40	DOOR LOCK 40MM B/SET CHROME	1	EA	5
716CP60	DOOR LOCK 60MM B/SET CHROME	1	EA	5



SOCKET BOLTS

SOCKET BOLTS - SOLID BRASS

Fixings supplied. 35mm length.
8mm Brass rod. Made from seamless Brass extrusion.

PRODUCT CODE	DESCRIPTION	QTY	PER	PCK
262FB0835BP	SOCKET BOLT (35MM) BRONZE	1	EA	10
262CP0835BP	SOCKET BOLT (35MM) CHROME	1	EA	10
262BR0835BP	SOCKET BOLT (35MM) BRASS	1	EA	10
262SC0835BP	SOCKET BOLT (35MM) S/CHROME	1	EA	10



SOCKET BOLTS - SOLID BRASS

Fixings supplied. 50mm length.
8mm Brass rod. Made from seamless Brass extrusion.

PRODUCT CODE	DESCRIPTION	QTY	PER	PCK
262FB0850BP	SOCKET BOLT (50MM) BRONZE	1	EA	10
262CP0850BP	SOCKET BOLT (50MM) CHROME	1	EA	10
262BR0850BP	SOCKET BOLT (50MM) BRASS	1	EA	10
262SC0850BP	SOCKET BOLT (50MM) S/CHROME	1	EA	10



SOCKET BOLTS - SOLID BRASS

Fixings supplied. 60mm length.
8mm Brass rod. Made from seamless Brass extrusion.

PRODUCT CODE	DESCRIPTION	QTY	PER	PCK
262FB0860BP	SOCKET BOLT (60MM) BRONZE	1	EA	10
262CP0860BP	SOCKET BOLT (60MM) CHROME	1	EA	10
262BR0860BP	SOCKET BOLT (60MM) BRASS	1	EA	10
262SC0860BP	SOCKET BOLT (60MM) S/CHROME	1	EA	10



SOCKET BOLTS - SOLID BRASS

Fixings supplied. 75mm length.
8mm Brass rod. Made from seamless Brass extrusion.

PRODUCT CODE	DESCRIPTION	QTY	PER	PCK
262FB0875BP	SOCKET BOLT (75MM) BRONZE	1	EA	10
262CP0875BP	SOCKET BOLT (75MM) CHROME	1	EA	10
262BR0875BP	SOCKET BOLT (75MM) BRASS	1	EA	10
262SC0875BP	SOCKET BOLT (75MM) S/CHROME	1	EA	10

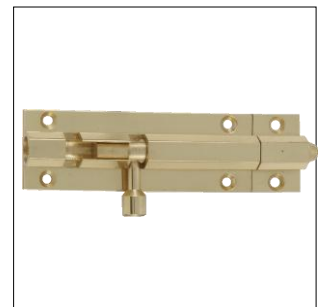

SOCKET BOLTS - SOLID BRASS

Fixings supplied. 100mm length.
8mm Brass rod. Made with seamless Brass extrusion.

PRODUCT CODE	DESCRIPTION	QTY	PER	PCK
262FB08100BP	SOCKET BOLT (100MM) BRONZE	1	EA	10
262CP08100BP	SOCKET BOLT (100MM) CHROME	1	EA	10
262BR08100BP	SOCKET BOLT (100MM) BRASS	1	EA	10
262SC08100BP	SOCKET BOLT (100MM) S/CHROME	1	EA	10



SOCKET BOLTS

SOCKET BOLTS - SOLID BRASS

Fixings supplied. 150mm length.
10mm Brass rod. Made from seamless brass extrusion.

PRODUCT CODE	DESCRIPTION	QTY	PER	PCK
262FB10150	SOCKET BOLT (150MM) BRONZE	1	EA	10
262CP10150	SOCKET BOLT (150MM) CHROME	1	EA	10
262BR10150	SOCKET BOLT (150MM) BRASS	1	EA	10
262SC10150	SOCKET BOLT (150MM) S/CHROME	1	EA	10

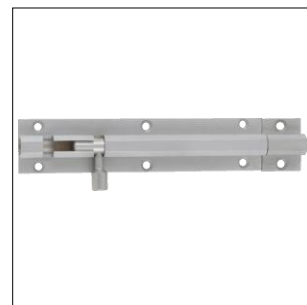

SOCKET BOLTS - SOLID BRASS

Fixings supplied. 200mm length.
10mm Brass rod. Made from seamless brass extrusion.

PRODUCT CODE	DESCRIPTION	QTY	PER	PCK
262FB10200	SOCKET BOLT (200MM) BRONZE	1	EA	10
262CP10200	SOCKET BOLT (200MM) CHROME	1	EA	10
262BR10200	SOCKET BOLT (200MM) BRASS	1	EA	10
262SC10200	SOCKET BOLT (200MM) S/CHROME	1	EA	10



SOCKET BOLTS - STAPLE ONLY

Suits 8mm #262 socket bolts.
Made from solid Brass.

PRODUCT CODE	DESCRIPTION	QTY	PER	PCK
262FB08S	SOCKET BOLT STAPLE BRONZE	1	EA	20
262CP08S	SOCKET BOLT STAPLE CHROME	1	EA	20
262BR08S	SOCKET BOLT STAPLE BRASS	1	EA	20
262SC08S	SOCKET BOLT STAPLE S/CHROME	1	EA	20



SOCKET BOLTS - STAPLE ONLY

Suits 10mm #262 socket bolts.
Made from solid Brass.

PRODUCT CODE	DESCRIPTION	QTY	PER	PCK
262FB10S	SOCKET BOLT STAPLE BRONZE	1	EA	20
262CP10S	SOCKET BOLT STAPLE CHROME	1	EA	20
262BR10S	SOCKET BOLT STAPLE BRASS	1	EA	20
262SC10S	SOCKET BOLT STAPLE S/CHROME	1	EA	20



SOCKET BOLTS - BRASS

Fixings supplied. 35mm length.
7mm Brass rod. Made with an open seam body.

PRODUCT CODE	DESCRIPTION	QTY	PER	PCK
462FB0835BP	SOCKET BOLT (35MM) BRONZE	1	EA	20
462CP0835BP	SOCKET BOLT (35MM) CHROME	1	EA	20
462BR0835BP	SOCKET BOLT (35MM) BRASS	1	EA	20
462SC0835BP	SOCKET BOLT (35MM) S/CHROME	1	EA	20



SOCKET BOLTS

SOCKET BOLTS - BRASS

Fixings supplied. 50mm length.
7mm Brass rod. Made with an open seam body.

PRODUCT CODE	DESCRIPTION	QTY	PER	PCK
462FB0850BP	SOCKET BOLT (50MM) BRONZE	1	EA	20
462CP0850BP	SOCKET BOLT (50MM) CHROME	1	EA	20
462BR0850BP	SOCKET BOLT (50MM) BRASS	1	EA	20
462SC0850BP	SOCKET BOLT (50MM) S/CHROME	1	EA	20



SOCKET BOLTS - BRASS

Fixings supplied. 75mm length.
7mm Brass rod. Made with an open seam body.

PRODUCT CODE	DESCRIPTION	QTY	PER	PCK
462FB0875BP	SOCKET BOLT (75MM) BRONZE	1	EA	20
462CP0875BP	SOCKET BOLT (75MM) CHROME	1	EA	20
462BR0875BP	SOCKET BOLT (75MM) BRASS	1	EA	20
462SC0875BP	SOCKET BOLT (75MM) S/CHROME	1	EA	20



SOCKET BOLTS - BRASS

Fixings supplied. 100mm length.
7mm Brass rod. Made with an open seam body.

PRODUCT CODE	DESCRIPTION	QTY	PER	PCK
462FB08100BP	SOCKET BOLT (100MM) BRONZE	1	EA	20
462CP08100BP	SOCKET BOLT (100MM) CHROME	1	EA	20
462BR08100BP	SOCKET BOLT (100MM) BRASS	1	EA	20
462SC08100BP	SOCKET BOLT (100MM) S/CHROME	1	EA	20



SOCKET BOLTS - BRASS

Fixings supplied. 150mm length.
9mm Brass rod. Made with an open seam body.

PRODUCT CODE	DESCRIPTION	QTY	PER	PCK
462FB10150	SOCKET BOLT (150MM) BRONZE	1	EA	20
462CP10150	SOCKET BOLT (150MM) CHROME	1	EA	20
462BR10150	SOCKET BOLT (150MM) BRASS	1	EA	20
462SC10150	SOCKET BOLT (150MM) S/CHROME	1	EA	20



WINDOW FITTINGS

QUADRANT STAY - ZINC DIECAST

Fixings supplied.

For spare screw use code 034** where ** indicates finish code. I.e. 034BR
For screw & base use code 035** where ** indicates finish code. I.e. 035BR

PRODUCT CODE	DESCRIPTION	QTY	PER	PCK
033BR	QUADRANT STAY BRASS FINISH	1	EA	10
033CP	QUADRANT STAY CHROME	1	EA	10
033SC	QUADRANT STAY S/CHROME	1	EA	10
033FB	QUADRANT STAY BRONZE	1	EA	10

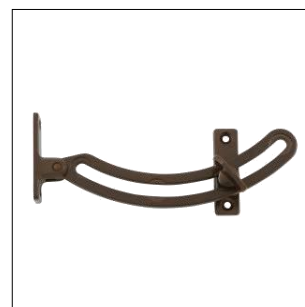

QUADRANT STAY - SOLID BRASS

Fixings supplied.

For spare screw use code 234** where ** indicates finish code. I.e. 234BR
For screw & base use code 235** where ** indicates finish code. I.e. 235BR

PRODUCT CODE	DESCRIPTION	QTY	PER	PCK
233BR	QUADRANT STAY POLISHED BRASS	1	EA	10
233CP	QUADRANT STAY CHROME	1	EA	10
233SC	QUADRANT STAY S/CHROME	1	EA	10
233FB	QUADRANT STAY BRONZE	1	EA	10



SPLIT RAIL FASTENER - ZINC DIECAST - LEFT HAND

Fixings supplied.

PRODUCT CODE	DESCRIPTION	QTY	PER	PCK
055BRL	SPLIT RAIL FASTENER BRASS	1	EA	20
055CPL	SPLIT RAIL FASTENER CHROME	1	EA	20
055SCL	SPLIT RAIL FASTENER S/CHROME	1	EA	20
055FBL	SPLIT RAIL FASTENER BRONZE	1	EA	20



SPLIT RAIL FASTENER - ZINC DIECAST - RIGHT HAND

Fixings supplied.

PRODUCT CODE	DESCRIPTION	QTY	PER	PCK
055BRR	SPLIT RAIL FASTENER BRASS	1	EA	20
055CPR	SPLIT RAIL FASTENER CHROME	1	EA	20
055SCR	SPLIT RAIL FASTENER S/CHROME	1	EA	20
055FBR	SPLIT RAIL FASTENER BRONZE	1	EA	20



WINDOW FITTINGS

SPLIT RAIL FASTENER - SOLID BRASS - LEFT HAND

Fixings supplied.
For top or side hinged windows.

PRODUCT CODE	DESCRIPTION	QTY	PER	PCK
236BRL	SPLIT RAIL FASTENER BRASS	1	EA	10
236CPL	SPLIT RAIL FASTENER CHROME	1	EA	10
236SCL	SPLIT RAIL FASTENER S/CHROME	1	EA	10



SPLIT RAIL FASTENER - SOLID BRASS - RIGHT HAND

Fixings supplied.
For top or side hinged windows.

PRODUCT CODE	DESCRIPTION	QTY	PER	PCK
236BRR	SPLIT RAIL FASTENER BRASS	1	EA	10
236CPR	SPLIT RAIL FASTENER CHROME	1	EA	10
236SCR	SPLIT RAIL FASTENER S/CHROME	1	EA	10



TELESCOPIC STAY - SOLID BRASS

Fixings supplied. Thumb turn friction stay. Size: 245mm, 378mm extended.
For thumb screw use code 247** where ** indicates finish code. I.e. 247BR

PRODUCT CODE	DESCRIPTION	QTY	PER	PCK
246BR	TELESCOPIC STAY BRASS	1	EA	20
246CP	TELESCOPIC STAY CHROME	1	EA	20
246SC	TELESCOPIC STAY S/CHROME	1	EA	20
246FB	TELESCOPIC STAY BRONZE	1	EA	20



RESTRICTED TELESCOPIC STAY - SOLID BRASS

Fixings supplied.
Opened length: 190mm overall.

PRODUCT CODE	DESCRIPTION	QTY	PER	PCK
248BR	TELESCOPIC STAY BRASS	1	EA	10
248CP	TELESCOPIC STAY CHROME	1	EA	10
248SC	TELESCOPIC STAY S/CHROME	1	EA	10
248FB	TELESCOPIC STAY BRONZE	1	EA	10



WINDLOCK STAY - SOLID BRASS

Fixings supplied.
Sprung finger plates hold the rod in any position.

PRODUCT CODE	DESCRIPTION	QTY	PER	PCK
264BR	WINDLOCK STAY BRASS	1	EA	20
264CP	WINDLOCK STAY CHROME	1	EA	20
264SC	WINDLOCK STAY S/CHROME	1	EA	20
264FB	WINDLOCK STAY BRONZE	1	EA	20



WINDOW FITTINGS

WINDLOCK FASTENER - SOLID BRASS

Fixings supplied.

PRODUCT CODE	DESCRIPTION	QTY	PER	PCK
266BR	WINDLOCK FASTENER BRASS	1	EA	20
266CP	WINDLOCK FASTENER CHROME	1	EA	20
266SC	WINDLOCK FASTENER S/CHROME	1	EA	20
266FB	WINDLOCK FASTENER BRONZE	1	EA	20



CASEMENT STAY - SOLID BRASS - 300MM

For side hinged windows. Fixings supplied.

For locking set use code 463**L where ** indicates finish code. I.e. 463BRL

PRODUCT CODE	DESCRIPTION	QTY	PER	PCK
463BR300	CASEMENT STAY BRASS	1	EA	5
463CP300	CASEMENT STAY CHROME	1	EA	5
463SC300	CASEMENT STAY S/CHROME	1	EA	5
463FB300	CASEMENT STAY BRONZE	1	EA	5



CASEMENT STAY - SOLID BRASS - 350MM

For side hinged windows. Fixings supplied.

For locking set use code 463**L where ** indicates finish code. I.e. 463BRL

PRODUCT CODE	DESCRIPTION	QTY	PER	PCK
463BR350	CASEMENT STAY BRASS	1	EA	5
463CP350	CASEMENT STAY CHROME	1	EA	5
463SC350	CASEMENT STAY S/CHROME	1	EA	5
463FB350	CASEMENT STAY BRONZE	1	EA	5



FANLIGHT STAY - SOLID BRASS

Fixings supplied. For top or side hinged windows. Size: 300mm.

For pin only use code 465**P where ** indicates finish code. I.e. 465BRP

PRODUCT CODE	DESCRIPTION	QTY	PER	PCK
465BR	FANLIGHT STAY BRASS	1	EA	5
465CP	FANLIGHT STAY CHROME	1	EA	5
465SC	FANLIGHT STAY S/CHROME	1	EA	5
465FB	FANLIGHT STAY BRONZE	1	EA	5



SASH LIFT - SOLID BRASS

Fixings supplied.

PRODUCT CODE	DESCRIPTION	QTY	PER	PCK
48BR4015	SASH LIFT BRASS	1	EA	10
48CP4015	SASH LIFT CHROME	1	EA	10
48SC4015	SASH LIFT S/CHROME	1	EA	10

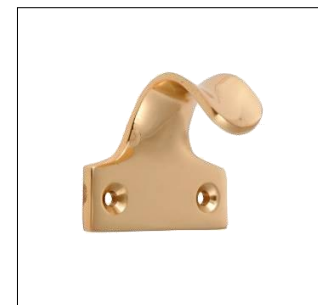

WINDOW FITTINGS

SASH FASTENER - SOLID BRASS

Fixings supplied.
For double hung windows.

PRODUCT CODE	DESCRIPTION	QTY	PER	PCK
48BR4036	SASH FASTENER BRASS	1	EA	10
48CP4036	SASH FASTENER CHROME	1	EA	10
48SC4036	SASH FASTENER S/CHROME	1	EA	10



SASH FITCH FASTENER - SOLID BRASS

Fixings supplied.
For double hung windows.

PRODUCT CODE	DESCRIPTION	QTY	PER	PCK
48BR4217	SASH FITCH FASTENER BRASS	1	EA	10
48CP4217	SASH FITCH FASTENER CHROME	1	EA	10
48SC4217	SASH FITCH FASTENER S/CHR.	1	EA	10



SPUR FASTENER - SOLID BRASS

Fixings supplied.
For top hinged windows.

PRODUCT CODE	DESCRIPTION	QTY	PER	PCK
48BR4320	SASH SPUR FASTENER BRASS	1	EA	10
48CP4320	SASH SPUR FASTENER CHROME	1	EA	10
48SC4320	SASH SPUR FASTENER S/CHROME	1	EA	10



WINDOW CLEATS - SOLID BRASS

Fixings supplied. Used to tidy blind & curtain cords.

PRODUCT CODE	DESCRIPTION	QTY	PER	PCK
058BR	WINDOW CLEAT (60MM) BRASS	1	EA	10
058CP	WINDOW CLEAT (60MM) CHROME	1	EA	10
059BR	WINDOW CLEAT (100MM) BRASS	1	EA	10
059CP	WINDOW CLEAT (100MM) CHROME	1	EA	10



WINDOW FITTINGS - E RANGE

CASEMENT STAY - ZINC ALLOY WITH BRASS ROD - 355MM

For side hinged windows. Fixings supplied.
Brass pins.

PRODUCT CODE	DESCRIPTION	QTY	PER	PCK
912BR355	CASEMENT STAY BRASS FINISH	1	EA	10
912CP355	CASEMENT STAY CHROME	1	EA	10
912FB355	CASEMENT STAY BRONZE	1	EA	10
912PW355	CASEMENTSTAY P/COAT WHITE	1	EA	10
912SC355	CASEMENT STAY SATIN CHROME	1	EA	10



FANLIGHT STAY - ZINC ALLOY WITH BRASS ROD - 305MM

For top or side hinged windows. Fixings supplied.

PRODUCT CODE	DESCRIPTION	QTY	PER	PCK
913BR305	FANLIGHT STAY BRASS FINISH	1	EA	10
913CP305	FANLIGHT STAY CHROME	1	EA	10
913FB305	FANLIGHT STAY BRONZE	1	EA	10
913SC305	FANLIGHT STAY SATIN CHROME	1	EA	10



SPLIT RAIL FASTENER - ZINC ALLOY - LEFT HAND

For side or top hinged windows. Fixings supplied.

PRODUCT CODE	DESCRIPTION	QTY	PER	PCK
914BRLH	SPLIT RAIL FASTNR BRASS FINISH	1	EA	10
914CPLH	SPLIT RAIL FASTENER CHROME	1	EA	10
914FBLH	SPLIT RAIL FASTENER BRONZE	1	EA	10
914PWLH	SPLIT RAIL FASTNR P/COAT WHITE	1	EA	10
914SCLH	SPLIT RAIL FASTENER S/CHROME	1	EA	10



SPLIT RAIL FASTENER - ZINC ALLOY - RIGHT HAND

For side or top hinged windows. Fixings supplied.

PRODUCT CODE	DESCRIPTION	QTY	PER	PCK
914BRRH	SPLIT RAIL FASTNR BRASS FINISH	1	EA	10
914CPRH	SPLIT RAIL FASTENER CHROME	1	EA	10
914FBRH	SPLIT RAIL FASTENER BRONZE	1	EA	10
914PWRH	SPLIT RAIL FASTNR P/COAT WHITE	1	EA	10
914SCRH	SPLIT RAIL FASTENER S/CHROME	1	EA	10



WINDOW FITTINGS - E RANGE

SPUR FASTENER - ZINC ALLOY

Fixings supplied.

PRODUCT CODE	DESCRIPTION	QTY	PER	PCK
915BR	FINISH SPUR FASTENER BRASS	1	EA	10
915CP	SPUR FASTENER CHROME	1	EA	10
915FB	SPUR FASTENER BRONZE	1	EA	10
915PW	SPUR FASTENER P/COAT WHITE	1	EA	10
915SC	SPUR FASTENER SATIN CHROME	1	EA	10



STANDARD WEDGE FASTENER - ZINC ALLOY

Fixings supplied.

PRODUCT CODE	DESCRIPTION	QTY	PER	PCK
916BR	WEDGE FASTENER BRASS FINISH	1	EA	10
916CP	WEDGE FASTENER CHROME	1	EA	10
916FB	WEDGE FASTENER BRONZE	1	EA	10
916PW	WEDGE FASTENER P/COAT WHITE	1	EA	10
916SC	WEDGE FASTENER SATIN CHROME	1	EA	10



TELESCOPIC STAY - ZINC ALLOY WITH BRASS ROD

Fixings supplied.
Zinc with Brass rod and body.

PRODUCT CODE	DESCRIPTION	QTY	PER	PCK
917BR200	TELESCOPIC STAY BRASS FINISH	1	EA	10
917CP200	TELESCOPIC STAY CHROME	1	EA	10
917FB200	TELESCOPIC STAY BRONZE	1	EA	10
917PW200	TELESCOPIC STAY P/COAT WHITE	1	EA	10
917SC200	TELESCOPIC STAY S/CHROME	1	EA	10



WEDGE FASTENER - BRASS

Fixings supplied.

PRODUCT CODE	DESCRIPTION	QTY	PER	PCK
918BR	WEDGE FASTENER POL. BRASS	1	EA	10
918CP	WEDGE FASTENER CHROME	1	EA	10
918FB	WEDGE FASTENER BRONZE	1	EA	10
918PW	WEDGE FASTENER P/COAT WHITE	1	EA	10
918SC	WEDGE FASTENER S/CHROME	1	EA	10



WINDOW FITTINGS - E RANGE

CRESCENT FASTENER - ZINC ALLOY

Fixings supplied.

PRODUCT CODE	DESCRIPTION	QTY	PER	PCK
920BR	CRESCENT FASTNR BRASS FINISH	1	EA	10
920CP	CRESCENT FASTENER CHROME	1	EA	10
920PW	CRECENT FASTENER WHITE	1	EA	10
920SC	CRESCENT FASTENER S/CHROME	1	EA	10



WINDOW FITTINGS - NORDIC

NORDIC NON-LOCKING FANLIGHT STAY

European inspired design.
250mm overall length.

PRODUCT CODE	DESCRIPTION	QTY	PER	PCK
257PWNL	FANLIGHT STAY WHITE N/L.	1	EA	20
257SCNL	FANLIGHT STAY S/CHROME N/L.	1	EA	20



NORDIC LOCKING FANLIGHT STAY

European inspired design.
Extra security in the closed position.
250mm overall length

PRODUCT CODE	DESCRIPTION	QTY	PER	PCK
257PWLK	FANLIGHT STAY WHITE LOCK.	1	EA	20
257SCLK	FANLIGHT STAY S/CHROME LOCK.	1	EA	20



NORDIC NON-LOCKING COCKSPUR

European inspired design.
Right and left handed fitments.

PRODUCT CODE	DESCRIPTION	QTY	PER	PCK
255PWNLLH	COCKSPUR (LH) WHITE N/L.	1	EA	20
255SCNLLH	COCKSPUR (LH) S/CHROME N/L.	1	EA	20
255PWNLRH	COCKSPUR (RH) WHITE N/L.	1	EA	20
255SCNLRH	COCKSPUR (RH) S/CHROME N/L.	1	EA	20



WINDOW FITTINGS – NORDIC

NORDIC LOCKING COCKSPUR

European inspired design. Provides additional security.
Right and left handed fittings.

PRODUCT CODE	DESCRIPTION	QTY	PER	PCK
255PWLKLH	COCKSPUR (LH) WHITE N/L.	1	EA	20
255SCLKLH	COCKSPUR (LH) S/CHROME N/L.	1	EA	20
255PWLKRH	COCKSPUR (RH) WHITE N/L.	1	EA	20
255SCLKRH	COCKSPUR (RH) S/CHROME N/L.	1	EA	20

