



Surface Mounted Door Closers

Surface Mounted Door Closers

Designed and manufactured to exacting standards. These world recognised standards ensure the highest possible quality, efficiency and reliable performance.

All models (except hold-open) are tested and approved on fire doors in accordance with Australian Standard AS1905:1:1997 Fire Resistant Doorsets.

New multi functional designs offer the specifier, stockist or the installer outstanding versatility and low inventory levels.

Effective door installation requires that the door and frame be of sufficient strength or reinforced to ensure secure anchorage of the door closer unit.

A door fitted with a door closer must be hung on good quality, aligned hinges so it swings freely without bias in both directions.

The closed door must be clear in the door frame and when a lock is fitted the latch bolt must engage freely within the strike.

When specifying manually operated door closers the following should be considered: door size, in particular width of door; door weight; type of installation; environmental conditions; location of door; operation frequency of door; the people using the door.

Door size and the pressure exerted on the surface area of the door due to wind gusts or air conditioning and the spring strength required to hold or close the door against this pressure must be considered along with the ability of the user to exert the force necessary to push or pull the door open. The location of door furniture will influence the leverage available to the person opening the door.

Selection of door closer size is judged in two ways.

1. Does the door closer have the strength to effectively close the door against unexpected air pressures?
2. Is the door closer oversized for the application and therefore affecting the ease of operation?

Efficiency of the door closer also has a major bearing on ease of operation. For optimum performance it is essential that a highly efficient door closer of a correct size is selected.

The use of spring strength adjustability, which allows fine tuning of strength on site, has simplified this task but not removed all of the guesswork. With more architects and engineers becoming conscious of the problems caused by incorrect selection of door closer strength, it has become the responsibility of manufacturers to provide better technical information, such as closing torque and efficiency of their products.

The following chart has been produced to cover most conditions. If you have an unusual application which you feel requires special consideration, please forward all relevant information to your local office and we will be happy to advise the best door control for your application.

Fire doors and pressurised stairwells pose significant challenges in ensuring closing and latching of fire doors. The problems are created by differential air pressures resulting from air conditioning systems on either side of the door. To achieve complete fire safety, fire doors must latch securely at all times. If this performance is not achieved the stairwell may be unsafe, and in the event of fire, loss of life and property may occur. Correct selection of door hardware is of paramount importance in ensuring that the appropriate operating standards are met.

Fire doors which open into a pressurised stairwell must meet the following criteria:

- the door must close against a pressure differential between the air conditioned floor area and non-air conditioned stairwell;
- the door must latch securely every time it closes;
- the door must be able to be opened with a force not exceeding 110N when the stairwell is pressurised; and
- the door must be protected from damage when it is opened by means of a back check action which is built into the door closer.

Note

- Always round up to the next door width (i.e. for 870 mm door use 950 mm).
- If parallel arm installation, then use next door width (i.e. for 830 mm door use 950 mm).
- For internal doors deduct 200 mm from actual door width (i.e. for 1250 mm internal door use 1050 mm).
- This chart is based on normal climatic conditions (i.e. pressure differential of 30Pa or wind of 15 knots).
- If more severe conditions are expected then use the next door width or consult the office in your location (refer back page).
- When specifying parallel arm and slide rail functions, allowance should be made for the following power loss:

Parallel Arm Mounting (7700/3024/2024 Series Rack and Pinion Range)

Approximately 20 % power loss

Slide Rail Mounting (7700/3024/2024 Series Rack and Pinion Range)

Approximately 30 % power loss

Power Selection Chart

This chart will be most useful in selecting the correct door closer. Simply identify the dimensions of the appropriate door and select the recommended door closer.

The chart is intended as a guide only and as such the following variations should be taken into account when making your selection:

- Environmental factors such as the effect of wind or air conditioning pressures.
- An unsheltered external door is a door on which prevailing wind gusts will directly produce a "sail area" effect.
- A sheltered external door is a doorway which is protected by a wind break or wall which acts as a barrier against direct wind gusts.

Closer Selection Chart

Recommended Door Width	Door Weight (kg) Max	Closer PowerSize	ClosingTorque (Nm)
750	20	1	9 - <13
850	40	2	13 - <18
950	60	3	18 - <26
1100	80	4	26 - <37
1250	100	5	37 - <54
1400	120	6	54 - <87
1600	160	7	87 - <140

Surface Mounted Door Closers

2516 CAM Action Door Closer with Slide Arm

CAM Action Door Closer Range

The Lockwood 2516 CAM Action Door Closer is a premium, high quality door closing device. When opening a door fitted with a Lockwood 2516 CAM Action Door Closer, the force required is less than that of a rack and pinion type door closer and continues to decrease through the opening arc.

This aesthetically appealing, narrow profile CAM Action Door Closer is suited for public and commercial applications where children, the elderly and the disabled are likely to be using the door. For disabled toilet applications where a breakout feature is required, the double action of the mechanism allows the door to be operated in the opposite direction for easy access into the room.

The Lockwood 2516 is light to open, but its adjustable closing force is high enough for heavy duty applications. The 2516 is non-handed and therefore very easy to install – either on the inside of the door or on the door frame.

Features

- Adjustable spring power from size EN 1 to 6
- Delayed Action DA (standard)
- Easily adjustable arm height
- Adjustable closing speed
- Adjustable latching speed
- Back Check (BC) (built in)
- Hold-open 2516-152 (additional part)
- Opening damper 2516-153
- Cast aluminium body manufactured from high-performance silicon alloy
- Two pressure relief valves are a standard feature to protect against abuse
- High efficiency: 70 – 80%
- One model (2516) covers most applications. Right hand and left hand applications and pull side/push side applications.

Standard Finishes

Satin Stainless Steel	SSS
Polished Brass	PB
Silver	SIL



Fire Rated

The Lockwood 2516 CAM Action Door Closer has successfully been fire rated on fire door assemblies in accordance with Australian Standard AS 1905.1 - 2005: Fire Resistant Doorsets.

Part Number

Satin Stainless Steel	2516DASSS
Polished Brass	2516DAPB
Silver	2516DASIL

Dimensions

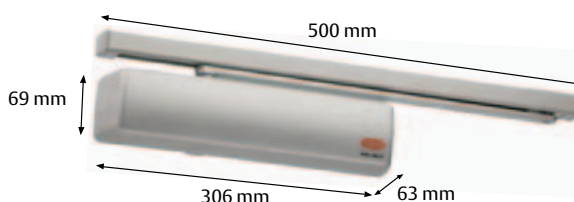

Movement Curve

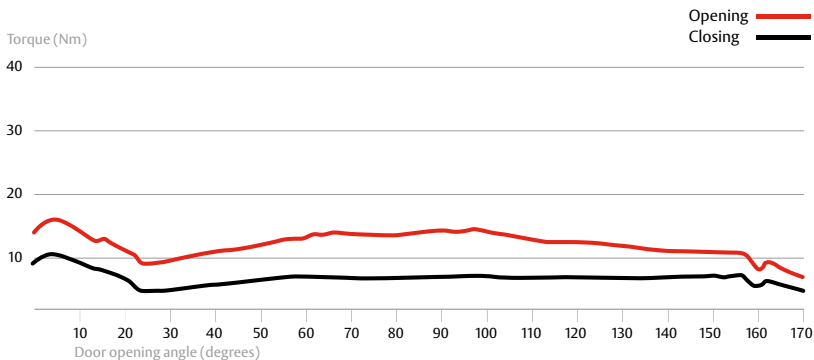

Note: Movement curve represents approximate forces required to operate a size 1 door closer. The illustration is an approximation based on one set of parameters. Any change to these parameters will result in a variation of performance.

Surface Mounted Door Closers

2516 CAM Action Door Closer with Slide Arm

Pull Side - Standard Mounting

Non hold-open permits door opening to 170°, and 160° when opening damper is used. When hold-open device is installed, the opening angle (hold-open) can be set to a maximum of 120°.

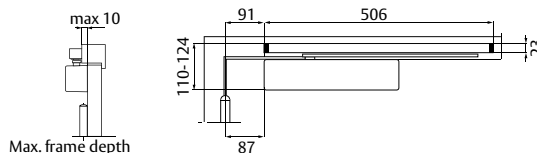

Push Side - Standard Mounting

Non hold-open permits door opening to 120°, and 110° when opening damper is used. When hold-open device is installed, the opening angle (hold-open) can be set to a maximum of 120°.

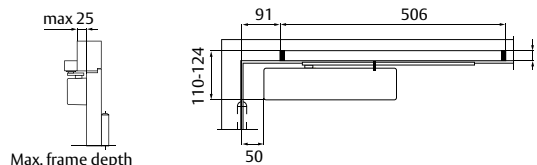

Push Side - Over-Door Mounting

Non hold-open permits door opening to 120°, and 110° when opening damper is used. When hold-open device is installed, the opening angle (hold-open) can be set to a maximum of 120°.

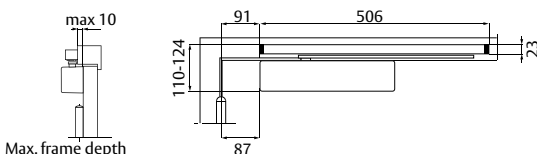

Pull Side - Over-Door Mounting

Non hold-open permits door opening to 170°, and 160° when opening damper is used. When hold-open device is installed, the opening angle (hold-open) can be set to a minimum of 120°.

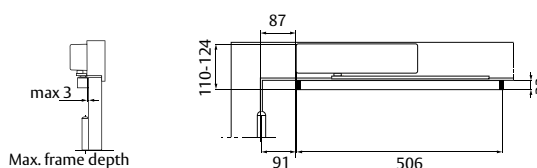

Angle Plate

2516-104 SIL

Allows the side rail to be installed below the door jamb. Required when the face of the door jamb exceeds 25 mm from the face of the door in the closed position.

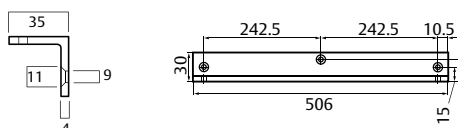

Mounting Plate

2516-180 SIL

For use on glazed doors with small top rail, this plate allows the closer to project below the top rail, at the same time concealing the back of the closer to enhance the appearance as seen through the glass.

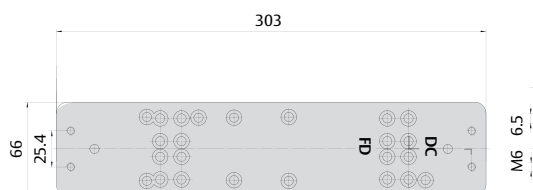

Adjustment

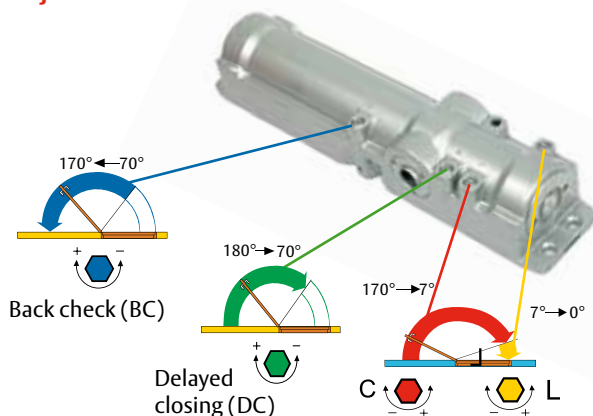

Surface Mounted Door Closers

2514 CAM Action Door Closer with Slide Arm

The Lockwood 2514 Series is a non-handed CAM Action Door Closer. Due to the CAM design this premium door closer is light to open but still strong enough to close a door. The Lockwood 2514 Door Closer can be adjusted to meet the requirements of a light door opening resistance and is ideal for both interior and exterior doors. The Lockwood 2514 Series is suitable for doors with a maximum door weight of 80kg and a door leaf width of 1100mm (sliding arm installation).

Features

- Adjustable spring power from size EN 1 to 4
- Cushioned back check (BC) 2516-153 - for fire door applications
- Easily adjustable arm height
- Adjustable closing speed
- Adjustable latching speed
- Hold-open 2516-152
- Cast aluminium body manufactured from high-performance silicon alloy
- Two pressure relief valves are a standard feature to protect against abuse
- High efficiency: 70 – 80%
- One model (2514) covers most applications. Right hand and left hand applications and pull side/push side applications.

Standard Finishes

Satin Stainless Steel	SSS
Silver	SIL



Fire Rated

The Lockwood 2514 CAM Action Door Closer has successfully been fire rated on fire door assemblies in accordance with Australian Standard AS 1905.1 - 2005: Fire Resistant Doorsets.

Part Number

Satin Stainless Steel	2514SSS
Silver	2514SIL

Dimensions



Movement Curve

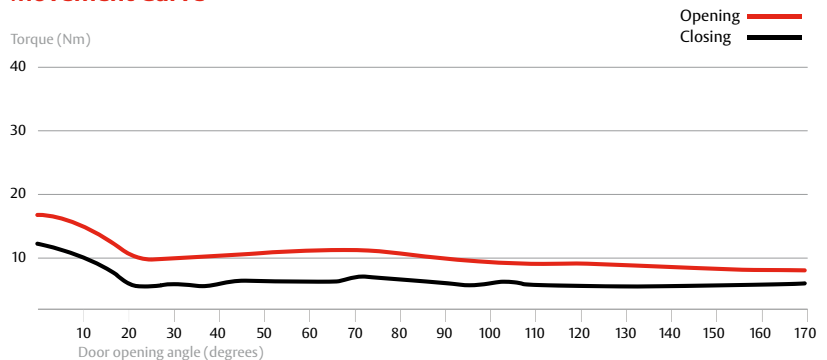

Note: Movement curve represents approximate forces required to operate a size 1 door closer. The illustration is an approximation based on one set of parameters. Any change to these parameters will result in a variation of performance.

Surface Mounted Door Closers

2514 CAM Action Door Closer with Slide Arm

Pull Side - Standard Mounting

Non hold-open permits door opening to 170°, and 160° when opening damper is used. When hold-open device is installed, the opening angle (hold-open) can be set to a maximum of 120°.

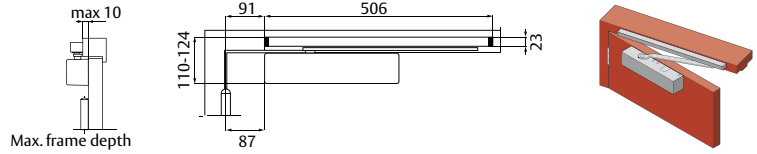

Push Side - Standard Mounting

Non hold-open permits door opening to 120°, and 110° when opening damper is used. When hold-open device is installed, the opening angle (hold-open) can be set to a maximum of 120°.

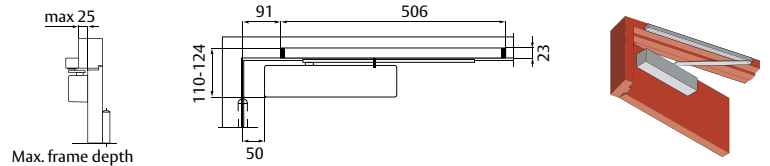

Push Side - Over-Door Mounting

Non hold-open permits door opening to 120°, and 110° when opening damper is used. When hold-open device is installed, the opening angle (hold-open) can be set to a maximum of 120°.

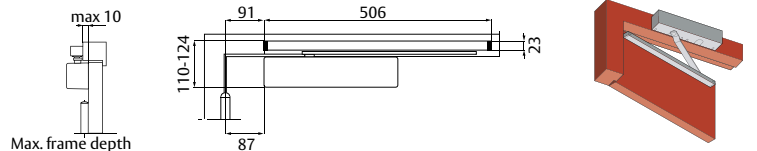

Pull Side - Over-Door Mounting

Non hold-open permits door opening to 170°, and 160° when opening damper is used. When hold-open device is installed, the opening angle (hold-open) can be set to a minimum of 120°.

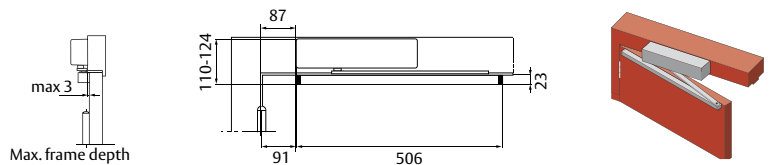

Angle Plate

2516-104 SIL

Allows the side rail to be installed below the door jamb. Required when the face of the door jamb exceeds 25 mm from the face of the door in the closed position.

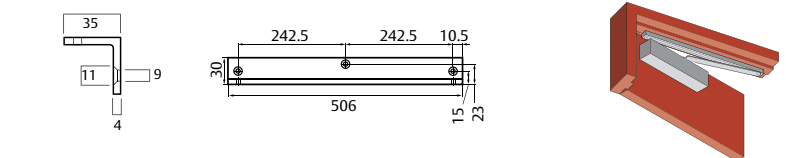

Mounting Plate

2516-180 SIL

For use on glazed doors with small top rail, this plate allows the closer to project below the top rail, at the same time concealing the back of the closer to enhance the appearance as seen through the glass.



Adjustment

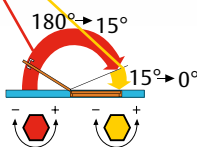

Closing and latching speed

Surface Mounted Door Closers

2557 Series Door Closer

The Lockwood 2557 Series is suitable for use on internal and external doors and is an ideal solution for extremely heavy doors. Maximum door weight 160kg and door leaf width 1600mm with standard arm installation.

Features

- Adjustable closing force from EN 5 to 7 (according to EN1154 standard)
- Separate adjusting valves for closing and latching speed
- Back check (BC) as a standard feature
- Wide operating temperature range: -35°C to +45°C
- Adjustable closing latching and back check valves
- Easy adjustment of arm height (14 mm)
- Two pressure relief valves to protect against abuse
- Die-cast aluminium body manufactured from high performance silicon alloy

Note: Parallel arm (push side) is not available on this model.

Part Number
2557SIL

Dimensions



Opening Side

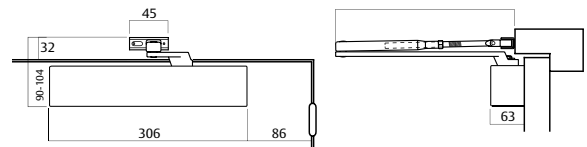
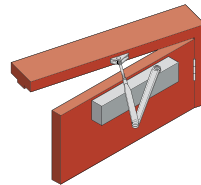

Closing Side

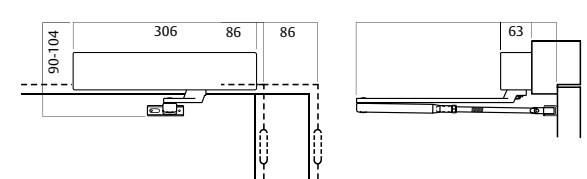
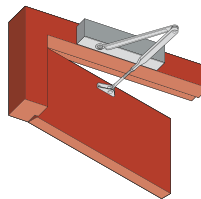

Adjustment

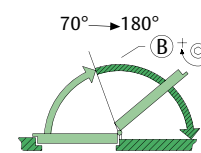
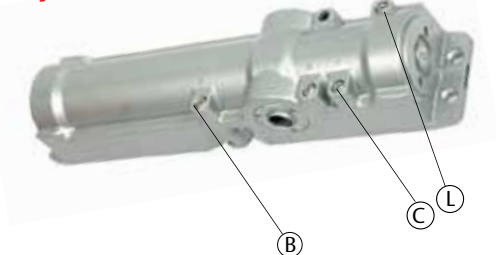

Back Check (BC)

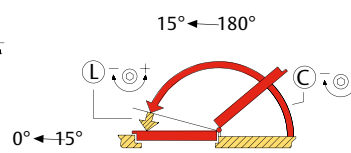

Closing and latching speed

Surface Mounted Door Closers

Accessories – 2516 and 2514 Series

Adjustment

Adjusting the Arm Height

The arm height can be adjusted (by a maximum of 14 mm) by moving the grooved spindle in a vertical direction.

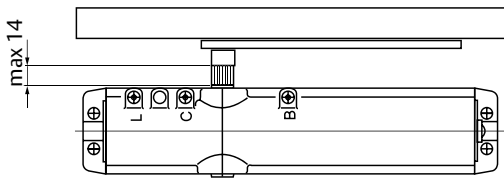

Closer Selection Chart

Door height should be a maximum of 2340mm

Recommended Door Width	Door Weight (kg) Max	Closer Power Size	Closing Torque (Nm)
750	20	1	9 - <13
850	40	2	13 - <18
950	60	3	18 - <26
1100	80	4	26 - <37
1250	100	5	37 - <54
1400	120	6	54 - <87
1600	160	7	87 - <140

Angle Plate – 2516-104 SIL

Allows the side rail to be installed below the door jamb. Required when the face of the door jamb exceeds 25mm from the face of the door in the closed position.

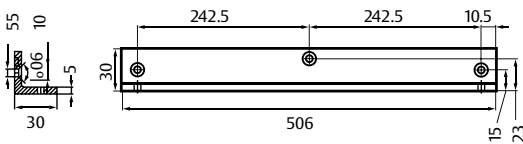

Drop Plate/Glass Door Trim Plate – 2516-180 SIL

For use on glazed doors with small top rail, this plate allows the closer to project below the top rail, at the same time concealing the back of the closer.

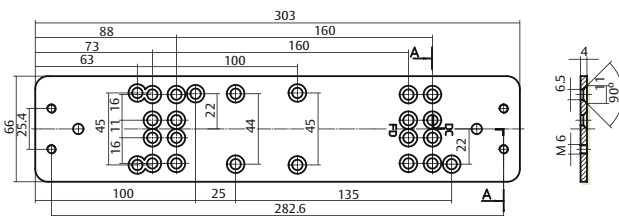

Accessories for Sliding Arm

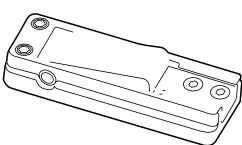

Hold-Open Device
2516-152

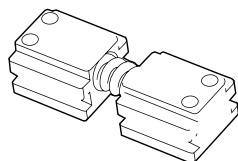

Opening Damper
2516-153

Surface Mounted Door Closers

Hydraulic Door Closers

Hydraulic Rack and Pinion Range



7726 Series Adjustable Power Hydraulic Door Closer



7714 Series Adjustable Power Hydraulic Door Closer



7724 Series Adjustable Power Hydraulic Door Closer



3024 Series Selectable Power Hydraulic Door Closer



2024 Series Hydraulic Door Closer

Surface Mounted Door Closers

Hydraulic Door Closers

Features and Specifications

Handing

Lockwood Door Closers are non-handed, therefore final assemblies are suitable for clockwise or anticlockwise opening doors.

Back Check

Back check is a standard feature on all models in this series. Back check cushions or slows the opening movement of the door prior to reaching the final open position.

Back check intensity is adjustable to allow for door size, door weight and closing power. It is mandatory on all fire doors.

Door Stops

Floor or wall mounted door stops should be fitted to prevent possible damage to the door unit or surrounds where a door may be subject to violent opening; to stop a door from being forced past the position where the arms are fully extended; or to stop a door at a specific position to clear feature walls, glass panels, furniture, etc.

Delayed Action

The delayed action is an independent valve and can either be adjusted as part of the closing sequence or independently adjusted for delayed action.

Such doors are particularly suitable for use by the disabled, the aged and people with prams or trolleys.

Sequence Selectors

When a pair of rebated doors are fitted with door closers it is essential that the doors close in their correct sequence. This closing sequence is achieved by the installation of a sequence selector.

Materials

Extruded aluminium body with hard anodised coating. Alloy steel rack and pinion mechanism operated by silicon chrome alloy steel springs and forged steel arms.

Overload Protection

Pressure relief valves are fitted to all units to prevent closer damage in the event of excessive force.

Fire Test

Approved on fire door assemblies up to 4 hours, in accordance with Australian Standards AS1905 Part 1 – Fire Resistant Doors 1984.

Standard Hold-Open

The hold-open device is located on the link arm and is activated by a cam. The position of the cam is adjustable to suit the desired hold-open position up to 150°.

The operation of the hold-open device does not limit the angle to which the door may be opened, as the door may be pushed past the hold-open position without affecting its operation.

A firm push or pull on the door will release the hold-open device.

Slide Rail Hold-Open

Hold-open is a standard feature for all slide arm door closers. It can be adjusted or disabled at any angle of the open arc.

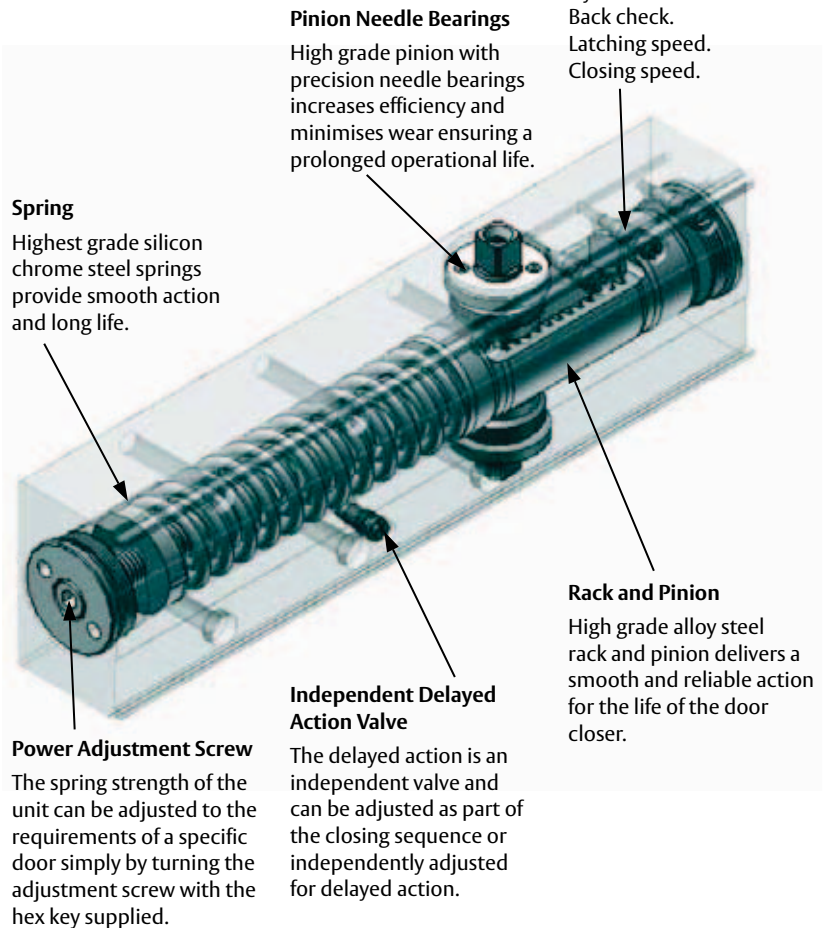

Surface Mounted Door Closers

Hydraulic Door Closers

Standard Features

	7726	7714	7724	3024	2024
Materials					
Extruded Aluminium body with hard anodised coating	✓	✓	✓	✓	
Alloy Steel Rack and Pinion Mechanism	✓	✓	✓	✓	✓
Silicon Chrome Steel Alloy Springs	✓	✓	✓	✓	✓
Forged Steel Arms	✓	✓	✓	✓	✓
Fully Formed Stainless Steel Box Cover	✓	✓	✓	✓	✓
Clip-on Cover			✓	✓	
High Grade Pinion Needle Bearings	✓	✓	✓	✓	✓
Power Adjustment					
Adjustable Power	✓	✓	✓		
Adjustable Power - Position				✓	✓
Power Size					
Power Size 1		✓			
Power Size 2	✓	✓	✓	✓	✓
Power Size 3	✓	✓	✓	✓	✓
Power Size 4	✓	✓	✓	✓	✓
Power Size 5	✓				
Power Size 6	✓				
Features					
Back Check	✓	✓	✓	✓	✓
Delayed Action	✓	✓			
Non-Handed	✓	✓	✓	✓	✓
Overload Protection	✓	✓	✓	✓	✓
Standard Arm	✓	✓	✓	✓	✓
Slide Arm	✓	✓	✓		
Over Door Mounting	✓	✓	✓	✓	✓
Standard Hold-Open	✓	✓	✓	✓	✓
Slide Arm Hold-Open	✓	✓	✓		
Fire Rated	✓	✓	✓	✓	✓
Finish					
Satin Stainless Steel	✓	✓	✓		
Polished Stainless Steel	✓	✓	✓		
Gold PVD on Stainless Steel	✓	✓			
Silver			✓	✓	✓
Gold	✓	✓	✓	✓	

Surface Mounted Door Closers

7726 Series Door Closer

A range of adjustable power door closer units suitable for architectural and commercial applications.

Standard Features

- Stainless steel cover
- 2 to 6 power adjustable
- Delayed action
- Adjustable back check
- Speed controls
- Overload protection
- Non-handed
- Regular, parallel and over-door mounting

Hold-Open

Hold-open can be set at any angle up to 150° of opening.

Standard Finishes

- | | |
|--------------------------|------------|
| Satin Stainless Steel | SSS |
| Polished Stainless Steel | PSS |
| Bright Gold | GLD |

FIRE RATED

Tested on fire door assemblies up to 4 hours in accordance with Australian Standard AS 1905.1-1997, Part 1: Fire Resistant Doorsets



7726 Standard Arm

Closer installed on pull side of door. This mounting position permits opening of 180°.

Part Numbers	
Non hold-open	7726
Hold-open	7726H

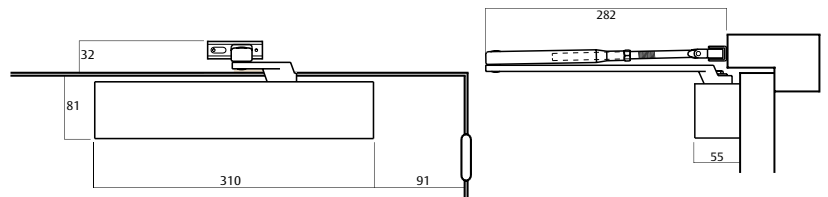
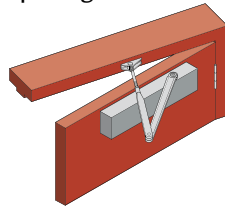

7726 Parallel Arm

Closer installed on push side of door. This mounting position permits opening of 180°.

Part Numbers	
Non hold-open	7726
Hold-open	7726H

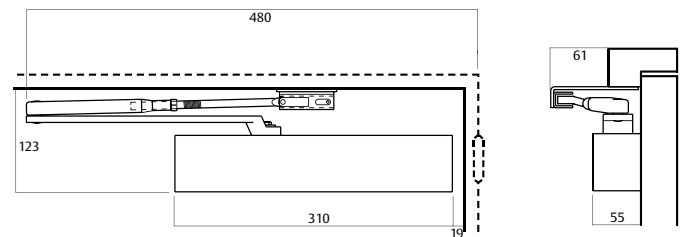
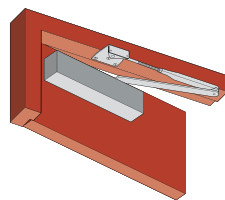

7726 Over Door Mounting

Closer installed on push side of door and top rail where conditions do not allow parallel mounting. This mounting position permits opening of 180°.

Part Numbers	
Non hold-open	7726
Hold-open	7726H

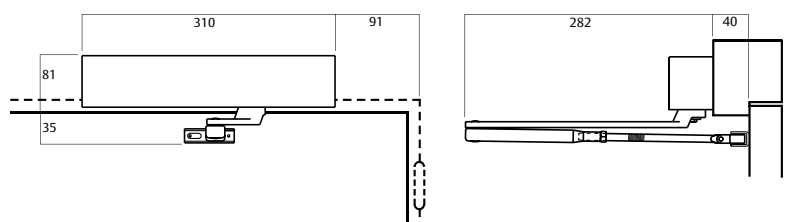
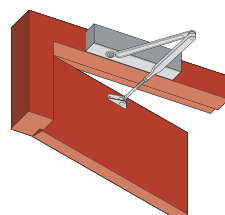

Surface Mounted Door Closers

7726 Series Slide Arm Door Closer

The Slide Arm Series permit smoother opening by way of reducing power as the door opens. Ideally suited for schools, hospitals or doors where children, disabled or the aged may enter.

Standard Features

- Stainless steel cover
- 2 to 5 power adjustable
- Delayed action
- Adjustable hold-open (inclusive)
- Adjustable back check
- Speed controls
- Overload protection
- Non-handed
- Regular and over-door mounting

7726 Slide Arm Pull Side

Closer installed on pull side of door. This mounting position permits opening of 130°.

Part Number

7726SR

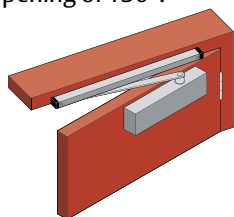

Hold-Open

Hold-open angle is the same as opening angle.

Standard Finishes

Satin Stainless Steel	SSS
Polished Stainless Steel	PSS
Bright Gold	GLD

FIRE RATED

Tested on fire door assemblies up to 4 hours in accordance with Australian Standard AS 1905.1-1997, Part 1: Fire Resistant Doorsets

7726 Slide Arm Push Side

Closer installed on push side of door. This mounting position permits opening of 130°.

Part Number

7726SR

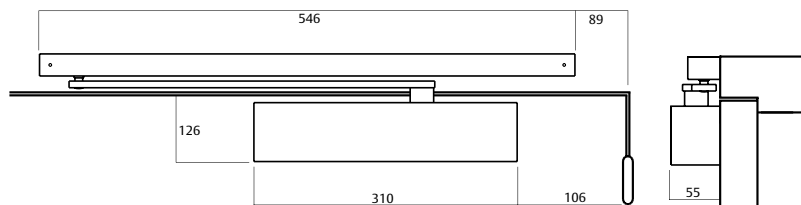
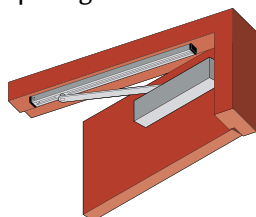

7726 Slide Arm Over Door Mounting Push Side

Closer installed on push side of door and top rail where conditions do not allow parallel mounting. This mounting position permits opening of 130°.

Part Number

7726SR

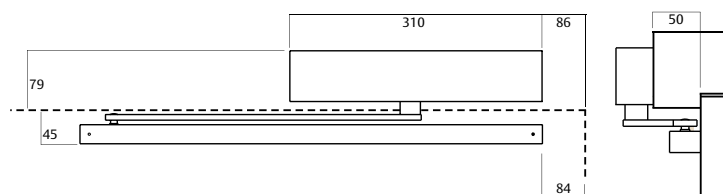
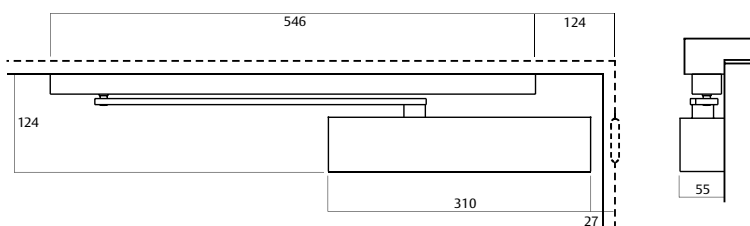
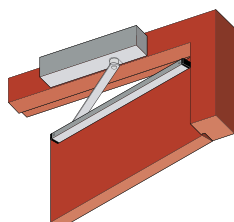

Surface Mounted Door Closers

7714 Series Door Closer

A range of adjustable power door closer units suitable for architectural and commercial applications.

Standard Features

- Stainless steel cover
- 1 to 4 power adjustable
- Delayed action
- Hold-open
- Adjustable back check
- Speed controls
- Overload protection
- Non-handed
- Regular, parallel and over-door mounting

Hold-Open

Hold-open can be set at any angle up to 150° of opening.

Standard Finishes

Satin Stainless Steel	SSS
Polished Stainless Steel	PSS
Bright Gold	GLD



FIRE RATED

Tested on fire door assemblies up to 4 hours in accordance with Australian Standard AS 1905.1-1997, Part 1: Fire Resistant Doorsets



7714 Standard Arm

Closer installed on pull side of door. This mounting position permits opening of 180°.

Part Numbers

Non hold-open	7714
Hold-open	7714H

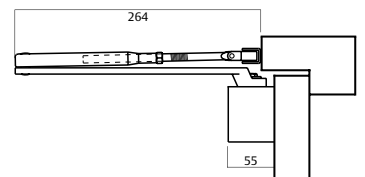
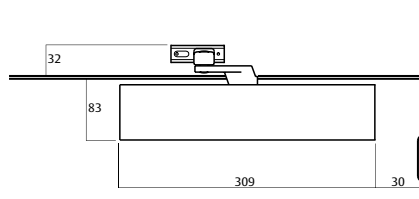
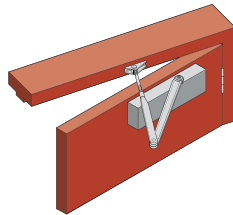

7714 Parallel Arm

Closer installed on push side of door. This mounting position permits opening of 180°.

Part Numbers

Non hold-open	7714
Hold-open	7714H

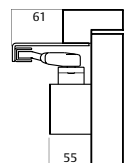
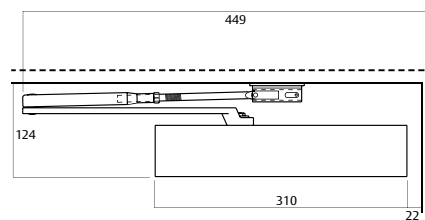
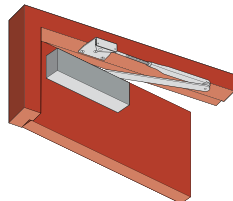

7714 Over Door Mounting

Closer installed on push side of door and top rail where conditions do not allow parallel mounting. This mounting position permits opening of 180°.

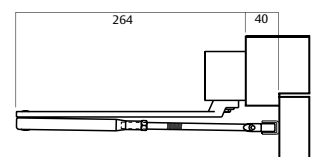
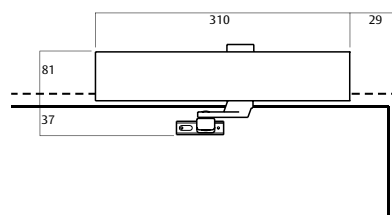
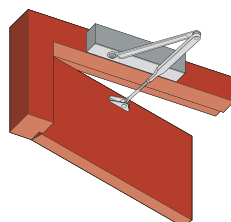

Surface Mounted Door Closers

7714 Series Slide Arm Door Closer

The Slide Arm Series permits smoother opening by way of reducing power as the door opens. Ideally suited for schools, hospitals or doors where children, disabled or the aged may enter.

Standard Features

- Stainless steel cover
- 1 to 3 power adjustable
- Delayed action
- Adjustable hold-open (inclusive)
- Adjustable back check
- Speed controls
- Overload protection
- Non-handed
- Regular and over-door mounting

7714 Slide Arm Pull Side

Closer installed on pull side of door. This mounting position permits opening of 130°.

Part Number

7714SR

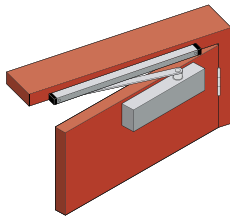

7714 Slide Arm Push Side

Closer installed on push side of door. This mounting position permits opening of 115°.

Part Number

7714SR

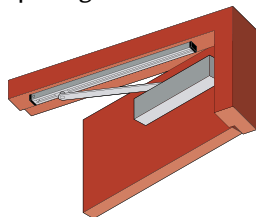

7714 Slide Arm Over Door Mounting Push Side

Closer installed on push side of door and top rail where conditions do not allow parallel mounting. This mounting position permits opening of 115°.

Part Number

7714SR

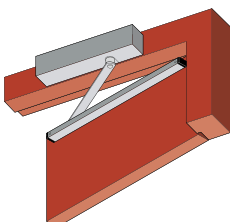

Hold-Open

Hold-open angle is the same as opening angle.

Standard Finishes

Satin Stainless Steel	SSS
Polished Stainless Steel	PSS
Bright Gold	GLD

FIRE RATED

Tested on fire door assemblies up to 4 hours in accordance with Australian Standard AS 1905.1-1997, Part 1: Fire Resistant Doorsets

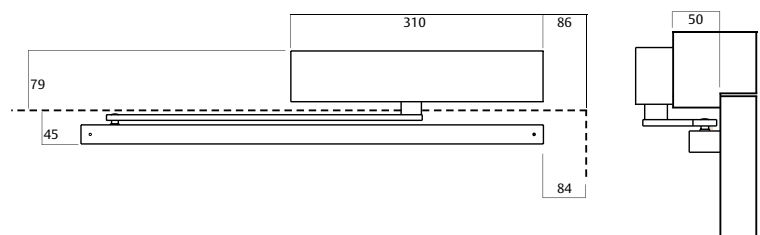
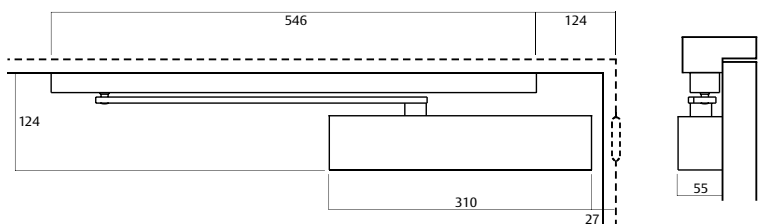
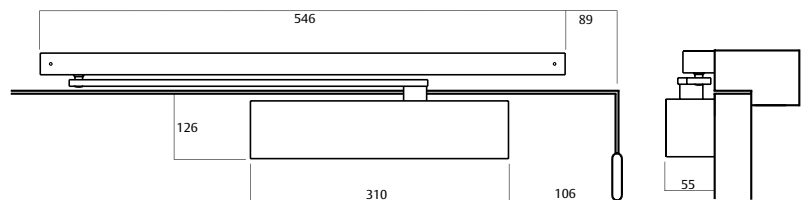

Surface Mounted Door Closers

7724 Series Door Closer

A range of adjustable power door closer units suitable for architectural and commercial applications.

Standard Features

- 2 to 4 power adjustable
- Hold-open
- Adjustable back check
- Speed controls
- Overload protection
- Non-handed
- Short arm - to suit 400 mm width door SP7724-130SIL

Hold-Open

Hold-open can be set at any angle up to 150° of opening.

Standard Finishes

Satin Stainless Steel	SSS
Polished Stainless Steel	PSS
Bright Gold	GLD

FIRE RATED

Tested on fire door assemblies up to 4 hours in accordance with Australian Standard AS 1905.1-1997, Part 1: Fire Resistant Doorsets



7724 Standard Arm

Closer installed on pull side of door. This mounting position permits opening of 130°.

Part Numbers	
Non hold-open	7724
Hold-open	7724H

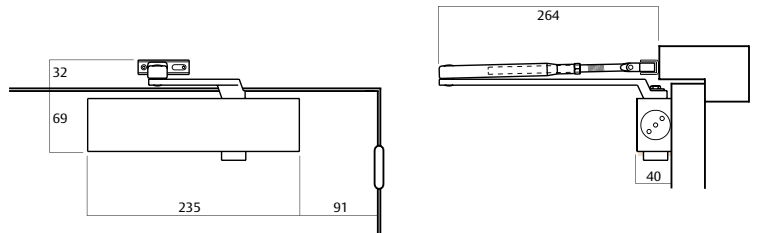
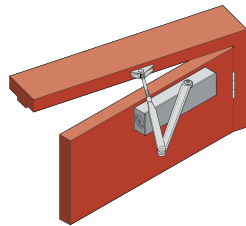

7724 Parallel Arm

Closer installed on push side of door. This mounting position permits opening of 180°.

Part Numbers	
Non hold-open	7724
Hold-open	7724H

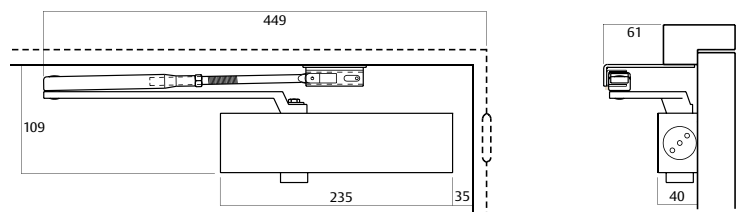
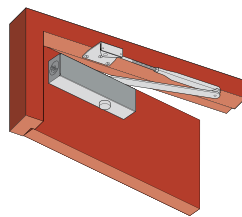

7724 Over Door Mounting

Closer installed on push side of door and top rail where conditions do not allow parallel mounting. This mounting position permits opening of 180°.

Part Numbers	
Non hold-open	7724
Hold-open	7724H

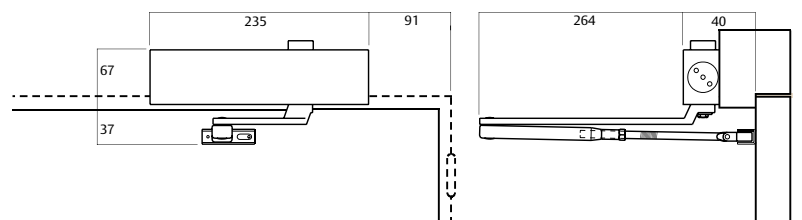
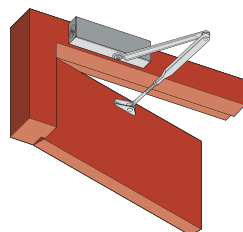

Surface Mounted Door Closers

7724 Series Slide Arm Door Closer

The Slide Arm Series permits smoother opening by way of reducing power as the door opens. Ideally suited for schools, hospitals or doors where children, disabled or the aged may enter.

Standard Features

- 2 to 3 power adjustable
- Adjustable hold-open (inclusive)
- Adjustable back check
- Speed controls
- Overload protection
- Non-handed
- Regular and over-door mounting

Hold-Open

Hold-open angle is the same as opening angle.



Standard Finishes

Satin Stainless Steel	SSS
Polished Stainless Steel	PSS
Silver	SIL



FIRE RATED

Tested on fire door assemblies up to 4 hours in accordance with Australian Standard AS 1905.1-1997, Part 1: Fire Resistant Doorsets

7724 Slide Arm Pull Side

Closer installed on pull side of door. This mounting position permits opening of 130°.

Part Number

7724SR

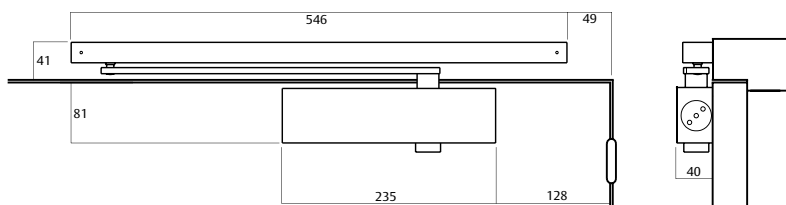
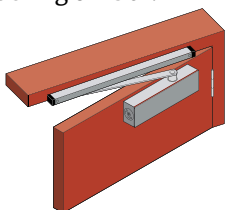

7724 Slide Arm Push Side

Closer installed on push side of door. This mounting position permits opening of 115°.

Part Number

7724SR

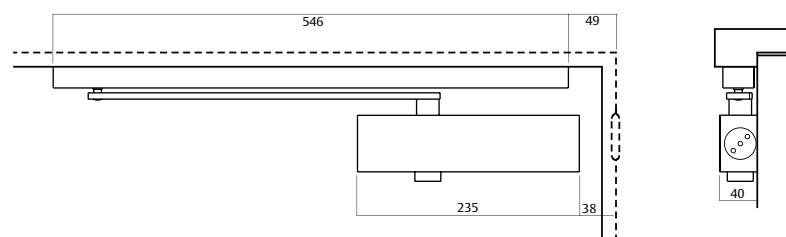
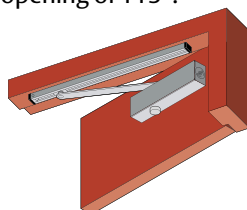

7724 Slide Arm Over Door Mounting Push Side

Closer installed on push side of door and top rail where conditions do not allow parallel mounting. This mounting position permits opening of 115°.

Part Number

7724SR

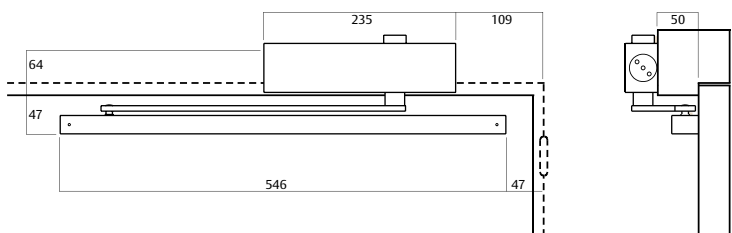
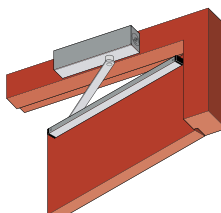

Surface Mounted Door Closers

3024 Series Door Closer

A range of adjustable power door closer units suitable for architectural and commercial applications.

Standard Features

- 2 to 4 power adjustable
- Hold-open
- Adjustable back check
- Speed controls
- Overload protection
- Non-handed
- Regular, parallel and over-door mounting

Hold-Open

Hold-open can be set at any angle up to 150° of opening.

Standard Finishes

Gold **GLD**

Silver **SIL**

Other finishes available on request.

FIRE RATED

Tested on fire door assemblies up to 4 hours in accordance with Australian Standard AS 1905.1-1997, Part 1: Fire Resistant Doorsets



3024 Standard Arm

Closer installed on pull side of door. This mounting position permits opening of 180°.

Part Numbers	
Non hold-open	3024
Hold-open	3024H

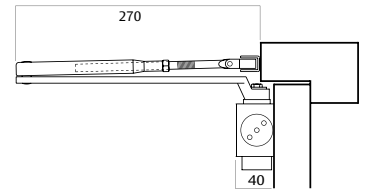
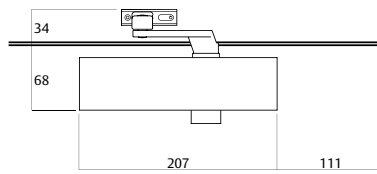
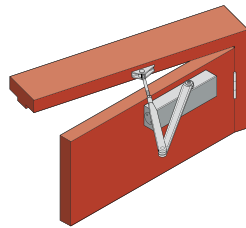

3024 Parallel Arm

Closer installed on push side of door. This mounting position permits opening of 180°.

Part Numbers	
Non hold-open	3024
Hold-open	3024H

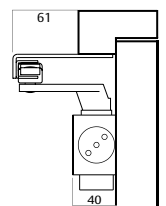
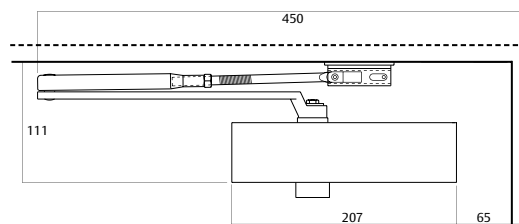
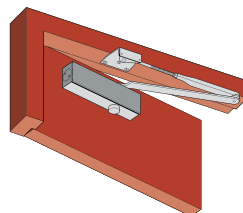

3024 Over Door Mounting

Closer installed on push side of door and top rail where conditions do not allow parallel mounting. This mounting position permits opening of 180°.

Part Numbers	
Non hold-open	3024
Hold-open	3024H

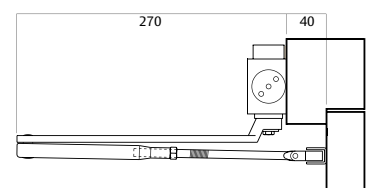
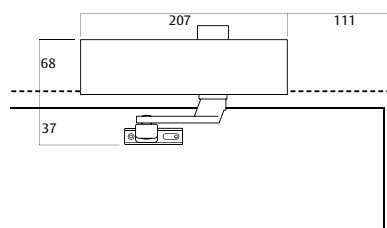
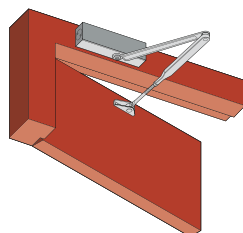

Surface Mounted Door Closers

2024 Series Door Closer

The Lockwood range of economy door closers is particularly quick and easy to install on most applications, ideally suitable where cost is a high priority. Multi position mounting template enables adjustment on site to meet most conditions also low stock holding as one model will cover 3 power sizes. Suitable for doors up to 1100 mm in width.

Specifications

Back check (adjustable)

Available in this series, specify BC if required. Back check cushions or slows the door prior to reaching final opening position.

Hold-open

Available in this series, specify HO.

Handing

Non-handed.
Suitable for left or right hand doors.

Adjustment

Independent valves control closing and latching speeds which can be readily adjusted on site when required.

Fire Doors



FIRE RATED

Approved on fire door assemblies up to 4 hours, in accordance with Australian Standards AS1905 Part 1 - Fire Resistant Doors 1984. Back check is required for all fire door applications.

Note: Hold-open option is not approved on any fire door.

Mechanism

Rack and pinion design.

Materials

High purity die cast aluminium housing with hardened steel rack and pinion mechanism.

Finish

Silver baked enamel.

Power Selection Charts

The power of the door closer is altered by adjusting the position of the door closer body on the mounting template.



Surface Mounted Door Closers

2024 Series Door Closer

Functions in Detail

All products include parallel arm bracket; multi strength mounting (one model covers size 2, 3, and 4); parallel arm size 2 and 3; 4 hour fire rating (back check version).

2024 Standard Arm

Closer installed on pull side of door. Standard mounting position permits door opening of 180°. If hold-open is installed the hold-open range is 80° to 165°.

Part Numbers

2024SIL

2024BCSIL

2024HSIL

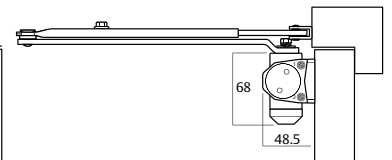
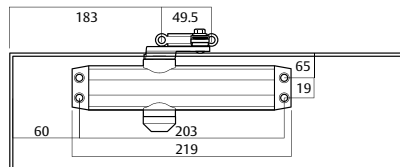
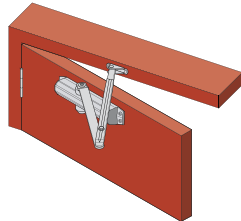

2024 Parallel Arm

Closer installed on push side of door. Standard mounting position permits door opening of 180°. If hold-open is installed the hold-open range is 80° to 165°.

Part Numbers

2024SIL

2024BCSIL

2024HSIL

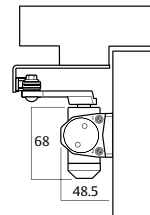
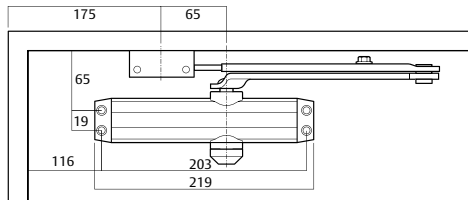
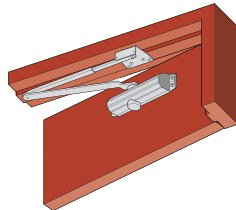

2024 Over Door Mounting

Closer installed on push side top rail where door conditions do not allow parallel mounting. Standard mounting position permits door opening of 180°. If hold-open is installed the hold-open range is 80° to 165°.

Part Numbers

2024SIL

2024BCSIL

2024HSIL

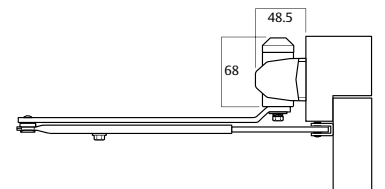
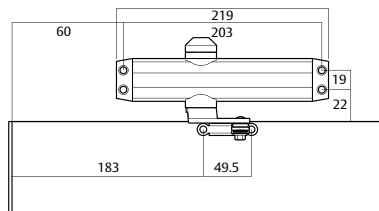
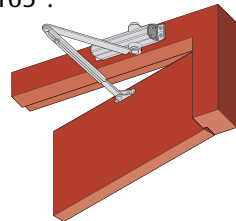

2024 Metal Door Mounting

Closer installed on push side of door to suit doorstop of 15 mm. Standard mounting position permits door opening of 180°. If hold-open is installed the hold-open range is 90° to 165°.

Part Number

2024BCPOSIL

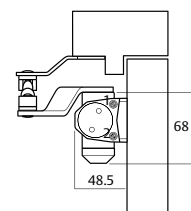
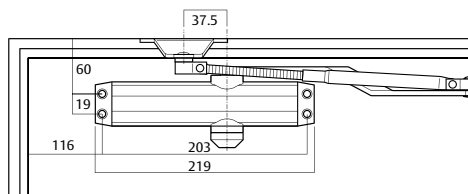
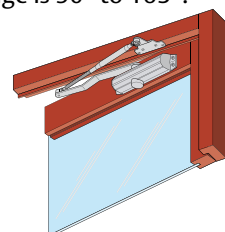

Surface Mounted Door Closers

Standard Hold-Open Arm

Description

- Surface mounted on push or pull side of door
- To hold the door open at any angle until the hold-open function is positively released by a slight pull action
- Adjustable up to 150° angle of the door closer opening range

Features and Specifications

The hold-open arm is suitable for both standard and parallel mounting.

The link arm is forged steel with a steel main arm finished in baked enamel.

Slide Arm Hold-Open

Adjustable Hold-Open Device

To set the hold-open angle move hold-open device to required position and firmly tighten screw.

If hold-open is not required do not tighten HO screw.

Delayed Action

The delayed action is an independent valve and can either be adjusted as part of the closing sequence or independently adjusted for delayed action.

Closing Sequence with Delayed Action

D = 130° - 70° Control door speed with delayed action valve

B = 70° - 15° Control door speed with closing valve

A = 15° - 0° Control door speed with latching valve

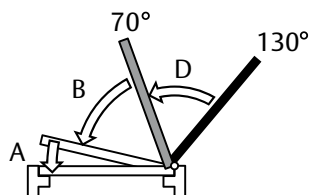
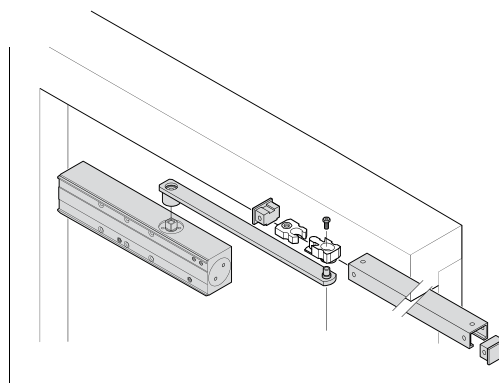
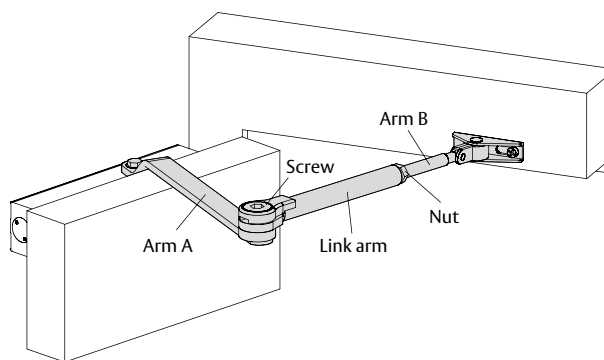

Surface Mounted Door Closers

Standard Hold-Open Arm

7726/7714 Drop Plate

Drop plate is available for fixing to doors with a small top rail. Four drilled and tapped holes are provided for easy installation of door closer.

Fitting of drop plate does not lower the position of door closer.

Suitable for Parallel Arm and Slide Arm. Push side applications only.

Part Number

7726-180SIL

7724 Drop Plate

Drop plate is available for fixing to doors with a small top rail. Four drilled and tapped holes are provided for easy installation of door closer.

Fitting of drop plate does not lower the position of door closer.

Suitable for Parallel Arm and Slide Arm. Push side applications only.

Part Number

7724-180SIL

3024 Drop Plate

Drop plate is available for fixing to doors with a small top rail. Four drilled and tapped holes are provided for easy installation of door closer.

Fitting of drop plate does not lower the position of door closer.

Suitable for Parallel Arm and Slide Arm. Push side applications only.

Part Number

3024-180SIL

3024 Trim Plate

When a closer is mounted to a glazed door the closer may project below the top rail.

To enhance the appearance as seen through the glass, a trim plate is available that conceals the back of the closer.

Also for regular and over door mounting on narrow aluminium frames.

Pull side applications only.

Part Number

3024-173SIL

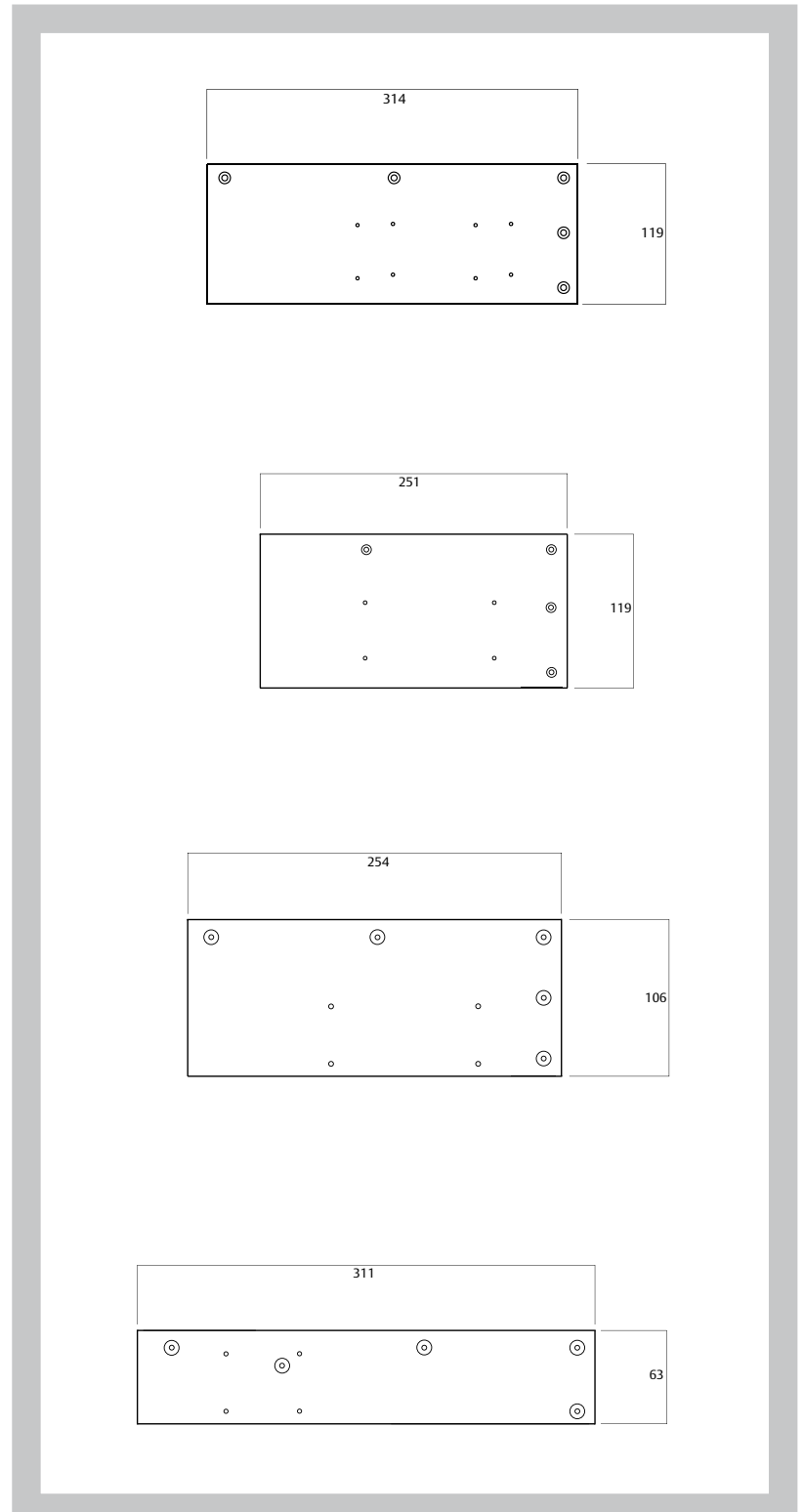

Surface Mounted Door Closers

Mechanical Door Coordinator

During the day the doors are normally closed and the active door is used as a passage door. If both doors need to stay open, the active door must be opened first (1), after which the inactive door can be opened (2). The coordinator holds the active door in the desired angle during the time the inactive door is open. The inactive door stays open only if someone holds it or a wall magnet is used. When the inactive door is closed (3), the active door starts to close (4).

Part Numbers

7726COSSS Satin Stainless Steel

7726COSIL Silver

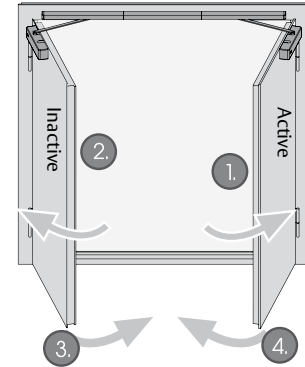

For Electromechanical Door Control Systems refer to page 4.35

Surface Mounted Door Closers

7726 Series Accessory Installation Examples

Opening Side - Single Door

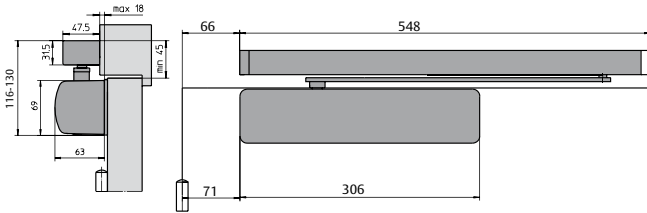

Closing Side - Single Door

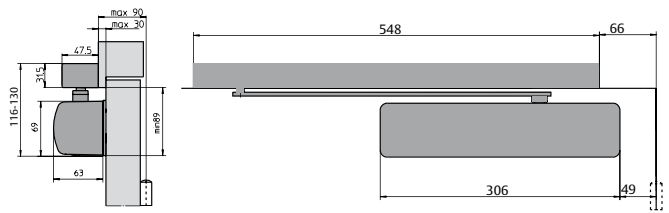

Opening Side - Double Door

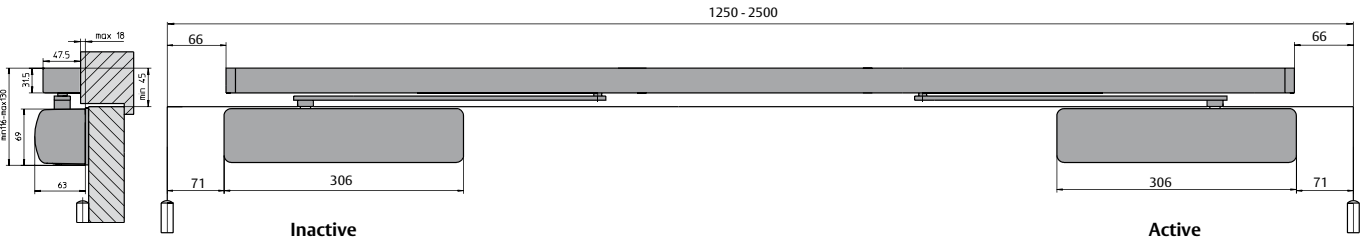

Closing Side - Double Door



Typical Limiting Dimensions

Flat mounting plate 7726-103 for single doors (double doors X 2)

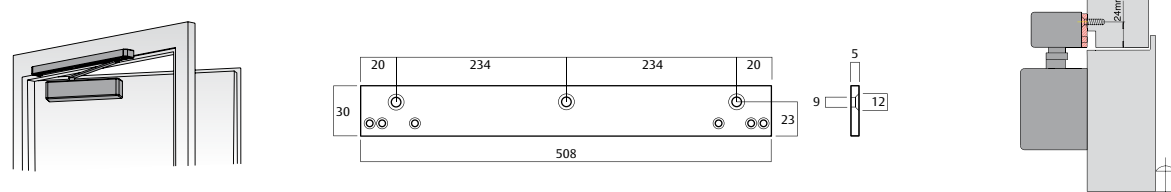

Flat mounting plate 7726-103 for single doors (double doors X 2)

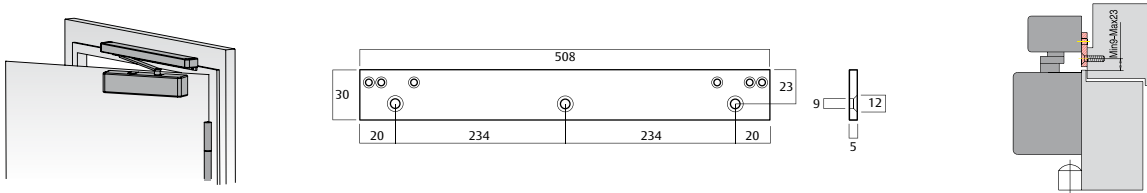

Angle mounting plate 7726-105 for single doors (double doors: 2 X 7726-105 plus centre piece 7726-109)

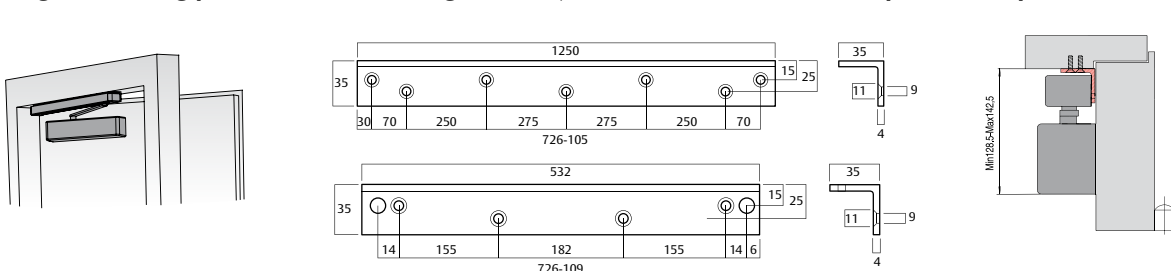

ASSA ABLOY is the global leader in door opening solutions, dedicated to satisfying end-user needs for security, safety and convenience



Lockwood is the leading brand in the Australian locking industry. With an established reputation for high quality products, this iconic brand provides a wide range of locking solutions to residential housing, commercial building and industrial application markets. Lockwood is supported by an extensive distribution and after-sales support network. Our customers include retailers, architects, trade and industrial personnel, locksmiths and security dealers.

ASSA ABLOY

ASSA ABLOY is the global leader in door opening solutions, dedicated to satisfying end-user needs for security, safety and convenience.

ASSA ABLOY is represented in all major regions, in both mature and emerging markets, with leading positions in Australia, Europe and North America.

As the world's leading lock group, ASSA ABLOY offers a more complete product range of door opening solutions than any other company in the market.

Australia
1300 LOCK UP (1300 562 587)
lockweb.com.au

New Zealand
+64 9415 7111
assaabloy.co.nz

ASSA ABLOY Australia Pty Ltd
235 Huntingdale Road
Oakleigh, Victoria, 3166
Australia

info.au@assaabloy.com
assaabloy.com.au

ASSA ABLOY New Zealand Ltd
6 Armstrong Road
Albany, North Shore City, 0632
New Zealand

info.nz@assaabloy.com
assaabloy.co.nz

